

MODEL 56086-4



# E REVO

BRUSHLESS EDITION

**TRAXXAS**

OWNER'S MANUAL

# INTRODUCTION

- 3 BEFORE YOU PROCEED
- 3 SAFETY PRECAUTIONS
- 5 TOOLS, SUPPLIES AND REQUIRED EQUIPMENT
- 6 ANATOMY OF THE E-REVO BRUSHLESS EDITION
- 7 QUICK START: GETTING UP TO SPEED
- 8 TRAXXAS TQi RADIO SYSTEM
- 16 ADJUSTING THE ELECTRONIC SPEED CONTROL
- 16 DRIVING YOUR MODEL
- 20 BASIC TUNING ADJUSTMENTS
- 26 MAINTAINING YOUR MODEL
- 27 ADVANCED TUNING ADJUSTMENTS
- 31 TQi ADVANCED TUNING GUIDE

Thank you for purchasing the Traxxas E-Revo Brushless Edition electric monster truck. The E-Revo is the most advanced electric racing monster truck ever created. We built the E-Revo for 6-cell LiPo and brushless power right from the start. E-Revo's driveline has been engineered to endure the horsepower and punishment that's possible with today's motor and battery technology. E-Revo Brushless Edition looks factory because it is factory, complete with a separate motor plate for clean, low-slung single motor installation. E-Revo Brushless Edition includes Power Cell NiMH batteries for Ready-To-Race fun right out of the box, and is ready for your choice of Power Cell LiPos—no modifications needed.

This manual contains the instructions you will need to operate and maintain your model so that you can enjoy it for years to come. We want you to feel confident that you own one of the best-performing models in the market and that it is backed by a team of professionals who aim to provide the highest level of factory support possible. Traxxas models are about experiencing total performance and satisfaction, not just with your model, but also with the company that stands behind it.

We know you're excited about getting your new model on the road, but it's very important that you take time to read through the Owners Manual. This manual contains all the necessary set-up and operating procedures that allow you to unlock the performance and potential that Traxxas engineers designed into your model. **Even if you are an experienced R/C enthusiast, it's important to read and follow the procedures in this manual.**

Thank you again for going with Traxxas. We work hard every day to assure you the highest level of customer satisfaction possible. We truly want you to enjoy your new model!

#### FCC Compliance

This device contains a module that complies with the limits for a Class B digital device as described in part 15 of the FCC rules. Operation is subject to the following two conditions: (1) This device may not cause harmful interference, and (2) this device must accept any interference received, including interference that may cause undesired operation.

The limits for a Class B digital device are designed to provide reasonable protection against harmful interference in residential settings. This product generates, uses, and can radiate radio frequency energy, and, if not operated in accordance with the instructions, may cause harmful interference to radio communications. The user is cautioned that changes or modifications not expressly approved by the party responsible for compliance could void the user's authority to operate the equipment.

#### Canada, Industry Canada (IC)

This Class B digital apparatus complies with Canadian ICES-003 and RSS-210. This device complies with Industry Canada license exempt RSS standard(s). Operation is subject to the following two conditions: This device may not cause interference, and this device must accept any interference, including interference that may cause undesired operation of the device.

#### Radio Frequency (RF) Exposure Statement

This equipment complies with radio frequency exposure limits set forth by FCC and Industry Canada for an uncontrolled environment. This equipment should be installed and operated with a minimum distance of 20 centimeters between the radiator and your body or bystanders and must not be co-located or operating in conjunction with any other antenna or transmitter.

#### Traxxas Support

Traxxas support is with you every step of the way. Refer to the next page to find out how to contact us and what your support options are.

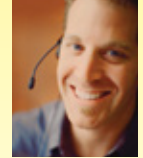

#### Quick Start

This manual is designed with a Quick Start path that outlines the necessary procedures to get your model up and running in the shortest time possible. If you are an experienced R/C enthusiast you will find it helpful and fast. Be sure and read through the rest of the manual to learn about important safety, maintenance, and adjustment procedures. Turn to page 7 to begin.



#### REGISTERING YOUR MODEL

In order to serve you better as our customer, please register your product within 10 days of your purchase online at [Traxxas.com/register](https://www.traxxas.com/register).

[Traxxas.com/register](https://www.traxxas.com/register)

Carefully read and follow all instructions in this and any accompanying materials to prevent serious damage to your model. Failure to follow these instructions will be considered abuse and/or neglect.

Before running your model, look over this entire manual and examine the model carefully. If for some reason you decide it is not what you wanted, then do not continue any further. **Your hobby dealer absolutely cannot accept a model for return or exchange after it has been run.**

### Warnings, Helpful Hints, & Cross-References

Throughout this manual, you'll notice warnings and helpful hints identified by the icons below. Be sure to read them!



An important warning about personal safety or avoiding damage to your model and related components.



Special advice from Traxxas to make things easier and more fun.



Refers you to a page with a related topic.

### SUPPORT

If you have any questions about your model or its operation, call the Traxxas Technical Support line toll-free at: **1-888-TRAXXAS (1-888-872-9927)\***

Technical support is available Monday through Friday from 8:30am to 9:00pm central time. Technical assistance is also available at Traxxas.com. You may also e-mail customer support with your question at support@Traxxas.com. Join thousands of registered members in our online community at Traxxas.com.

Traxxas offers a full-service, on-site repair facility to handle any of your Traxxas service needs. Maintenance and replacement parts may be purchased directly from Traxxas by phone or online at BuyTraxxas.com. You can save time, along with shipping and handling costs, by purchasing replacement parts from your local dealer.

Do not hesitate to contact us with any of your product support needs. We want you to be thoroughly satisfied with your new model!

\*Toll-free support is available to U.S. residents only.

## SAFETY PRECAUTIONS

All of us at Traxxas want you to safely enjoy your new model. Operate your model sensibly and with care, and it will be exciting, safe, and fun for you and those around you. Failure to operate your model in a safe and responsible manner may result in property damage and serious injury. The precautions outlined in this manual should be strictly followed to help ensure safe operation. You alone must see that the instructions are followed and the precautions are adhered to.

### Important Points to Remember

- Your model is not intended for use on public roads or congested areas where its operation can conflict with or disrupt pedestrian or vehicular traffic.
- Never, under any circumstances, operate the model in crowds of people. Your model is very fast and could cause injury if allowed to collide with anyone.
- Because your model is controlled by radio, it is subject to radio interference from many sources that are beyond your control. Since radio interference can cause momentary losses of radio control, always allow a safety margin in all directions around the model in order to prevent collisions.
- The motor, battery, and speed control can become hot during use. Be careful to avoid getting burned.
- Don't operate your model at night, or anytime your line of sight to the model may be obstructed or impaired in any way.
- **Most importantly, use good common sense at all times.**

### Batteries and Battery Charging

Your model uses rechargeable batteries that must be handled with care for safety and long battery life. Make sure to read and follow all instructions and precautions for charging and maintaining the batteries. It is your responsibility to charge and care for the battery packs properly. In addition to your battery and charger instructions, here are some more tips to keep in mind.

- Do not charge batteries inside of an automobile. Do not charge batteries while driving in an automobile.
- Never charge batteries on wood, cloth, carpet or on any other flammable material.
- Do not operate the charger in a cluttered space, or place objects on top of the charger or battery.
- If a battery gets hot to the touch during the charging process (temperature greater than 140°F / 60°C), disconnect the battery from the charger and discontinue charging immediately.
- Always store battery packs safely out of the reach of children and pets.
- Do not short-circuit the battery pack. This may cause burns and severe damage to the battery pack and create the risk of fire.
- Do not expose the charger to water or moisture.
- Do not disassemble the charger.
- Never leave batteries to charge unattended.
- Remove the battery from the model while charging.

Traxxas  
6250 Traxxas Way  
McKinney, Texas 75070  
Phone: 972-549-3000  
Toll-free 1-888-TRAXXAS

Internet  
Traxxas.com  
E-mail: support@Traxxas.com

Entire contents ©2016 Traxxas. Traxxas, Ready-To-Race, Ready-To-Win, E-Revo and ProGraphix are trademarks or registered trademarks of Traxxas. Other brand names and marks are the property of their respective holders and are used only for purposes of identification. No part of this manual may be reproduced or distributed in print or electronic media without the express written permission of Traxxas. Specifications are subject to change without notice.





All instructions and precautions outlined in this manual should be strictly followed to ensure safe operation of your model.



This model is not intended for use by children under 14 years of age without the supervision of a responsible and knowledgeable adult.



Previous experience with radio controlled models is recommended. Models require a higher level of setup, maintenance, or support equipment.

- Always unplug the battery from the electronic speed control when the model is not in use and when it is being stored or transported.
- Allow the battery pack to cool off between runs (before charging).
- Children should have responsible adult supervision when charging and handling batteries.
- Do not use battery packs that have been damaged in any way.
- Do not use battery packs that have damaged wiring, exposed wiring, or a damaged connector.
- Do not short-circuit the battery pack. This may cause burns and severe damage to the battery pack.
- Do not burn or puncture the batteries. Toxic materials could be released. If eye or skin contact occurs, flush with water.
- Store the battery pack in a dry location, away from heat sources and direct sunlight.
- Nickel Metal Hydride batteries must be recycled or disposed of properly.

#### Recycling Your Traxxas Power Cell NiMH Battery

Traxxas strongly encourages you to recycle your Power Cell NiMH battery when it has reached the end of its useful life. **Do not throw your battery in the trash.** All Power Cell NiMH battery packs display the RBRC (Rechargeable Battery Recycling Corporation) icon, indicating they are recyclable. To find a recycling center near you, ask your local hobby dealer or visit [www.call2recycle.org](http://www.call2recycle.org).

#### Speed Control

Your model's electronic speed control (ESC) is an extremely powerful electronic device capable of delivering high current. Please closely follow these precautions to prevent damage to the speed control or other components.

- Disconnect the Batteries: Always disconnect the batteries from the speed control when not in use.
- Transmitter on First: Switch on your transmitter first before switching on the speed control to prevent runaways and erratic performance.
- Always adhere to the minimum and maximum limitations of the ESC as stated in the specifications table. **Do not mix battery types and capacities. Use the same voltage and capacity for both batteries. Using mismatched battery packs could damage the batteries and electronic speed control.**

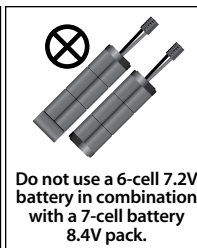

- Insulate the Wires: Always insulate exposed or damaged wiring with heat shrink tubing to prevent short circuits
- Don't Get Burned: The ESC and motor can become extremely hot during use, so be careful not to touch them until they cool. Supply adequate airflow for cooling.
- Use the Factory-Installed Connectors: Do not change the battery and motor connectors. Improper wiring can cause fire or damage to the ESC. Please note that modified speed controls can be subject to a rewiring fee when returned for service.
- No Reverse Voltage: The speed control is not protected against reverse polarity voltage.
- No Schottky Diodes: External Schottky diodes are not compatible with reversing speed controls. Using a Schottky diode with the ESC will damage the ESC and void the 30-day warranty.

#### LiPo Batteries

Lithium Polymer (LiPo) batteries are becoming popular for use in R/C models due to their compact size, high energy density, and high-current output; however, these types of batteries require special care and handling procedures for long life and safe operation. **WARNING: LiPo batteries are intended only for advanced users that are educated on the risks associated with LiPo battery use. Traxxas does not recommend that anyone under the age of 14 use or handle LiPo battery packs without the supervision of a knowledgeable and responsible adult.**

Your model is able to use LiPo batteries with nominal voltage not to exceed 11.1 volts (3S packs). LiPo batteries have a minimum safe discharge voltage threshold that should not be exceeded. The MXL-6s electronic speed control is equipped with built-in Low-Voltage Detection that alerts the driver when LiPo batteries have reached their minimum voltage (discharge) threshold. **It is the driver's responsibility to stop immediately to prevent the battery pack from being discharged below its safe minimum threshold.**

Low-Voltage Detection on the speed control is just one part of a comprehensive plan for safe LiPo battery use. **It is critical for you, the user, to follow all other instructions supplied by the battery manufacturer and the charger manufacturer for proper charging, use, and storage of LiPo batteries. Make sure you understand how to use your LiPo batteries.** Be aware that Traxxas shall not be liable for any special, indirect, incidental, or consequential damages arising out of the installation and/or use of LiPo batteries in Traxxas models. **If you have questions about LiPo battery usage, please consult with your local hobby dealer or contact the battery manufacturer.** As a reminder, all batteries should be recycled at the end of their useful life.



# TOOLS, SUPPLIES AND REQUIRED EQUIPMENT

Your model comes with a set of specialty metric tools. You'll need to purchase other items, available from your hobby dealer, to operate and maintain your model.

## Supplied Tools and Equipment

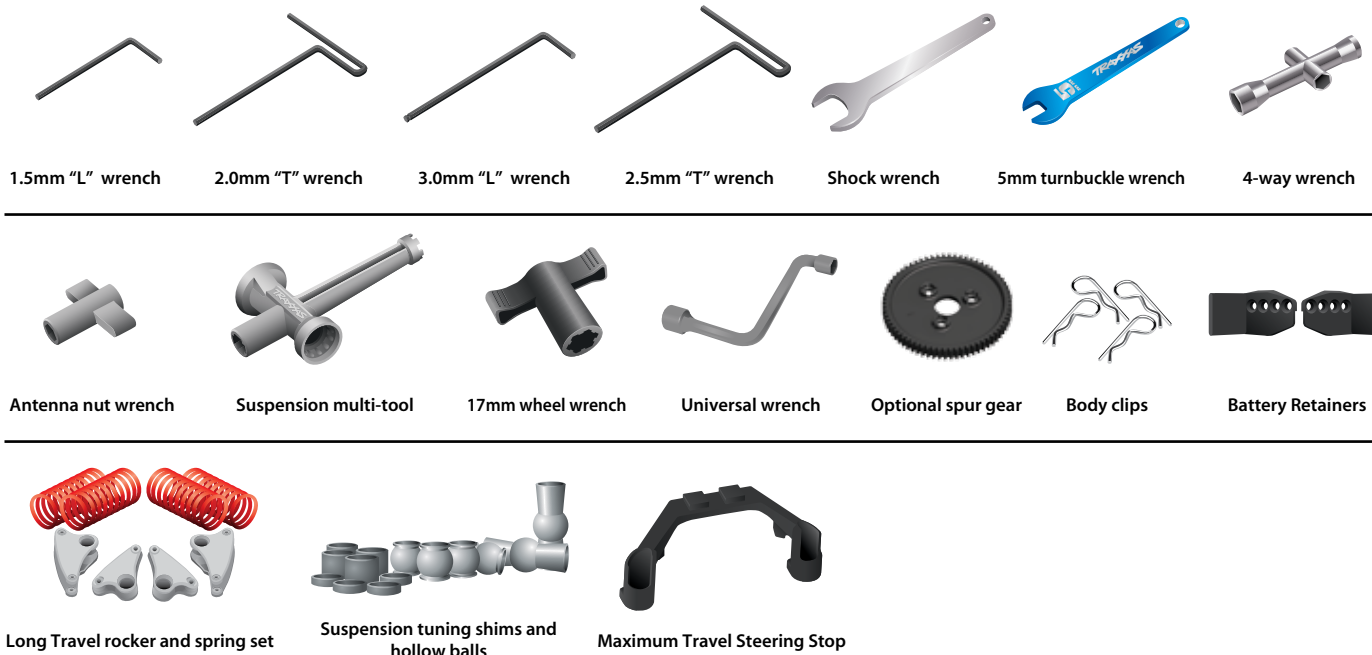

## Required Equipment (not included)



\*Battery and charger style is subject to change and may vary from images.



For more information on batteries, see *Use the Right Batteries* on page 11.



A peak-detecting charger is recommended for best performance and longest battery life. See [Traxxas.com](http://Traxxas.com) for more information.



**Recommended Equipment**  
 These items are not required for the operation of your model, but are a good idea to include in any R/C toolbox:

- Safety glasses
- Traxxas Ultra Premium Tire Glue, part #6468 (CA glue)
- Hobby knife
- Side cutters and/or needle nose pliers
- Phillips screwdriver
- Soldering iron

# ANATOMY OF THE E-REVO BRUSHLESS EDITION

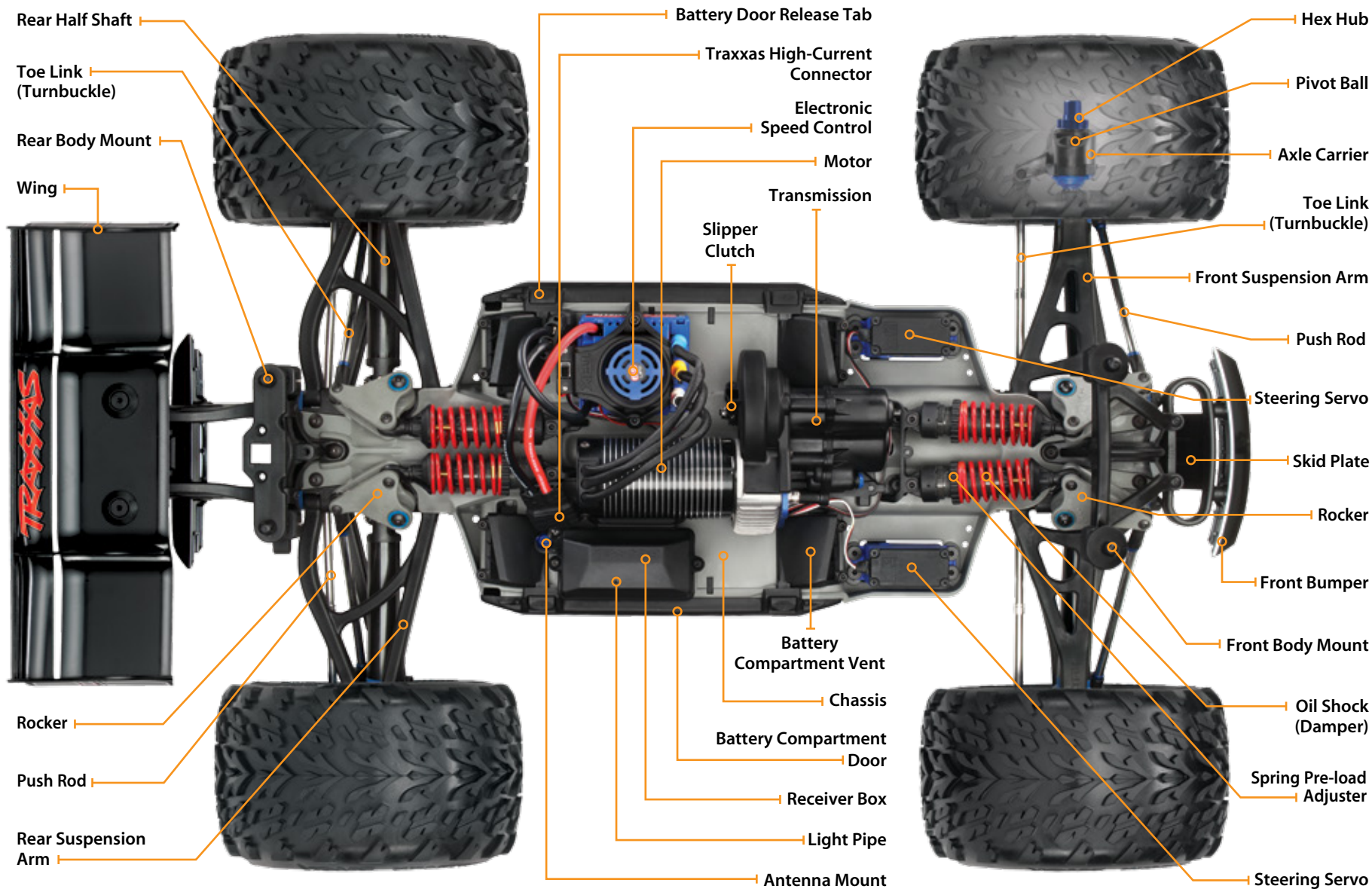

## QUICK START: GETTING UP TO SPEED

The following guide is an overview of the procedures for getting your model running. Look for the Quick Start logo on the bottom corners of Quick Start pages.

**1. Read the safety precautions on pages 3-4**

For your own safety, understand where carelessness and misuse could lead to personal injury.

**2. Charge the battery packs • See page 11**

Your model requires two battery packs and a compatible battery charger (not included). Never use a NiMH or NiCad charger to charge LiPo batteries.

**3. Install batteries in the transmitter • See page 11**

The transmitter requires 4 AA alkaline batteries (sold separately).

**4. Install battery packs in the model • See pages 12-13**

Your model requires two fully charged battery packs (not included).

**5. Turn on the radio system • See page 13**

Make a habit of turning the transmitter on first, and off last.

**6. Check servo operation • See page 14**

Make sure the steering servos are working correctly.

**7. Range test the radio system • See page 14**

Follow this procedure to make sure your radio system works properly at a distance and that there is no interference from outside sources.

**8. Detail your model • See page 8**

Apply other decals if desired.

**9. Drive your model • See page 16**

Driving tips and adjustments for your model.

**10. Maintaining your model • See page 26**

Follow these critical steps to maintain the performance of your model and keep it in excellent running condition.



The Quick Start Guide is not intended to replace the full operating instructions available in this manual. Please read this entire manual for complete instructions on the proper use and maintenance of your model.

Look for the Quick Start logo at the bottom of Quick Start pages.





## Applying the Decals

The main decals for your model have been applied at the factory. The decals are printed on self-adhesive clear mylar and are die-cut for easy removal. Use a hobby knife to lift the corner of a decal and lift it from the backing.

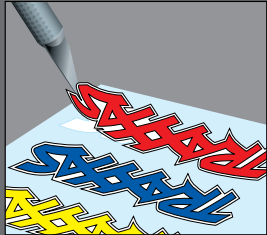

To apply the decals, place one end down, hold the other end up, and gradually smooth the decal down with your finger as you go. This will prevent air bubbles. Placing both ends of the decal down and then trying to smooth it out will result in air pockets. Look at the photos on the box for typical decal placement.

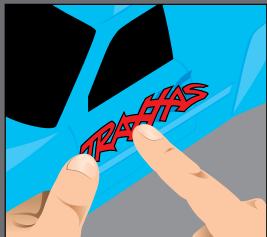

## INTRODUCTION

Your model includes the latest Traxxas TQi 2.4GHz transmitter with Traxxas Link™ Model Memory. The transmitter's easy-to-use design provides instant driving fun for new R/C enthusiasts, and also offers a full compliment of pro-level tuning features for advanced users – or anyone interested in experimenting with the performance of their model. The steering and throttle channels feature adjustable Exponential, End Points, and Sub-Trims. Steering and braking Dual Rate are also available. Many of the next-level features are controlled by the Multi-Function knob, which can be programmed to control a variety of functions. The detailed instructions (page 31) and Menu Tree (page 34) included in this manual will help you understand and operate the advanced functions of the new TQi radio system. For additional information and how-to videos, visit [Traxxas.com](http://Traxxas.com).

## RADIO AND POWER SYSTEM TERMINOLOGY

Please take a moment to familiarize yourself with these radio and power system terms. They will be used throughout this manual. A detailed explanation of the advanced terminology and features of your new radio system begins on page 31.

**2.4GHz Spread Spectrum** – This model is equipped with the latest R/C technology. Unlike AM and FM systems that require frequency crystals and are prone to frequency conflicts, the TQi system automatically selects and locks onto an open frequency, and offers superior resistance to interference and “glitching.”

**BEC (Battery Eliminator Circuit)** - The BEC can either be in the receiver or in the ESC. This circuit allows the receiver and servos to be powered by the main battery pack in an electric model. This eliminates the need to carry a separate pack of 4 AA batteries to power the radio equipment.

**Brushless Motor** - A D/C brushless motor replaces the brushed motor's traditional commutator and brush arrangement with intelligent electronics that energize the electromagnetic windings in sequence to provide rotation. Opposite of a brushed motor, the brushless motor has its windings (coils) on the perimeter of the motor can and the magnets are mounted to the spinning rotor shaft.

**Cogging** - Cogging is a condition sometimes associated with brushless motors. Typically it is a slight stutter noticed when accelerating from a stop. It happens for a very short period as the signals from the electronic speed control and the motor synch with each other.

**Current** - Current is a measure of power flow through the electronics, usually measured in amps. If you look at wire like a garden hose, current is a measure of how much water is flowing through the hose.

**ESC (Electronic Speed Control)** - An electronic speed control is the electronic motor control inside the model. Electronic speed controls use power more efficiently than mechanical speed controls so that the battery runs longer. An electronic speed control also has circuitry that prevents loss of steering and throttle control as the battery loses its charge.

**Frequency band** - The radio frequency used by the transmitter to send signals to your model. This model operates on the 2.4GHz direct-sequence spread spectrum.

**kV Rating** - Brushless motors are often rated by their kV number. The kV rating equals no-load motor rpm with 1 volt applied. The kV increases as the number of wire turns in the motor decreases. As the kV increases, the current draw through the electronics also increases.

**LiPo** - Abbreviation for Lithium Polymer. Rechargeable LiPo battery packs are known for their special chemistry that allows extremely high energy density and current handling in a compact size. These are high performance batteries that require special care and handling. For advanced users only.

**mAh** - Abbreviation for milliamp hour. A measure of the capacity of the battery pack. The higher the number, the longer the battery will last between recharges.

**Neutral position** - The standing position that the servos seek when the transmitter controls are at the neutral setting.





**NiCad** - Abbreviation for nickel-cadmium. The original rechargeable hobby pack, NiCad batteries have very high current handling, high capacity, and can last up to 1000 charging cycles. Good charging procedures are required to reduce the possibility of developing a “memory” effect and shortened run times.

**NiMH** - Abbreviation for nickel-metal hydride. Rechargeable NiMH batteries offer high current handling, and much greater resistance to the “memory” effect. NiMH batteries generally allow higher capacity than NiCad batteries. They can last up to 500 charge cycles. A peak charger designed for NiMH batteries is required for optimal performance.

**Receiver** - The radio unit inside your model that receives signals from the transmitter and relays them to the servos.

**Resistance** - In an electrical sense, resistance is a measure of how an object resists or obstructs the flow of current through it. When flow is constricted, energy is converted to heat and is lost. Traxxas power systems are optimized to reduce electrical resistance and the resulting power-robbing heat.

**Rotor** - The rotor is the main shaft of the brushless motor. In a brushless motor, the magnets are mounted to the rotor, and the electromagnetic windings are built into the motor housing.

**Sensored** - Sensored refers to a type of brushless motor that uses an internal sensor in the motor to communicate rotor position information back to the electronic speed control.

**Sensorless** - Sensorless refers to a brushless motor that uses advanced instructions from an electronic speed control to provide smooth operation. Additional motor sensors and wiring are not required.

**Servo** - Small motor unit in your model that operates the steering mechanism.

**Solder Tabs** - Accessible, external contacts on the motor that allows for easy wire replacement.

**Transmitter** - The hand-held radio unit that sends throttle and steering instructions to your model.

**Trim** - The fine-tuning adjustment of the neutral position of the servos, made by adjusting the throttle and steering trim knobs on the face of the transmitter. **Note:** The Multi-Function knob must be programmed to serve as a throttle trim adjustment.

**Thermal Shutdown Protection** - Temperature sensing electronics used in the electronic speed control detect overloading and overheating of the transistor circuitry. If excessive temperature is detected, the unit automatically shuts down to prevent damage to the electronics.

**2-channel radio system** - The TQi radio system, consisting of the receiver, the transmitter, and the servos. The system uses two channels: one to operate the throttle and one to operate the steering.

**Voltage** - Voltage is a measure of the electrical potential difference between two points, such as between the positive battery terminal and ground. Using the analogy of the garden hose, while current is the quantity of water flow in the hose, voltage corresponds to the pressure that is forcing the water through the hose.

#### IMPORTANT RADIO SYSTEM PRECAUTIONS

- Do not kink the receiver’s antenna wire. Kinks in the antenna wire will reduce range.
- DO NOT CUT any part of the receiver’s antenna wire. Cutting the antenna will reduce range.
- Extend the antenna wire in the model as far as possible for maximum range. It is not necessary to extend the antenna wire out of the body, but wrapping or coiling the antenna wire should be avoided.
- Do not allow the antenna wire to extend outside the body without the protection of an antenna tube, or the antenna wire may get cut or damaged, reducing range. It is recommended to keep the wire inside the body (in the antenna tube) to prevent the chance of damage.



To prevent loss of radio range do not kink or cut the black wire, do not bend or cut the metal tip, and do not bend or cut the white wire at the end of the metal tip.

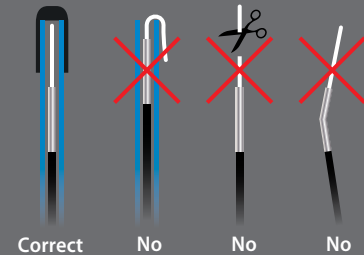

Wiring Diagram

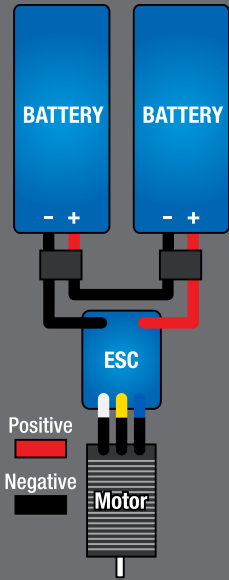

MXL-6s Electronic Speed Control Specifications:

Cells.....	18 NiCad / NiMH 6s LiPo
Resistance.....	0.0003 Ohms per phase
Brake.....	Proportional with adjustable curve
Reversible.....	Yes - with lockout
Low Voltage Cutoff.....	Programmable
Case Size.....	2.2" x 1.9" x 1.4"
Weight with Wires.....	121g
Connector Type.....	6.5mm bullet

Your model is equipped with the TQi 2.4GHz transmitter with the Traxxas Link Wireless Module. The transmitter has two channels for controlling your throttle and steering. The receiver inside the model has 5 output channels. Your model is equipped with two servos and an electronic speed control.

TRANSMITTER AND RECEIVER

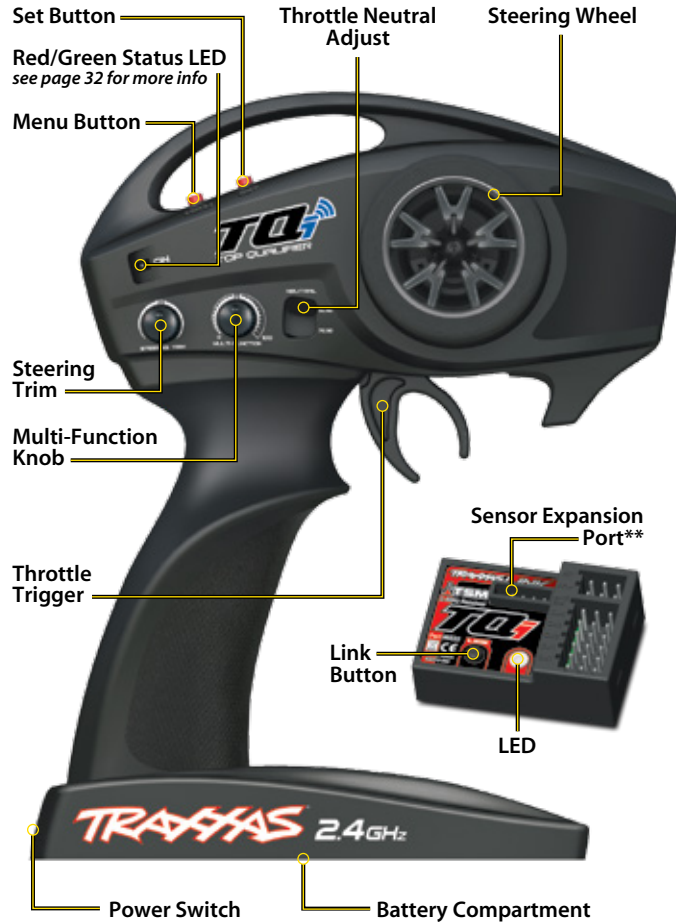

MODEL WIRING DIAGRAM

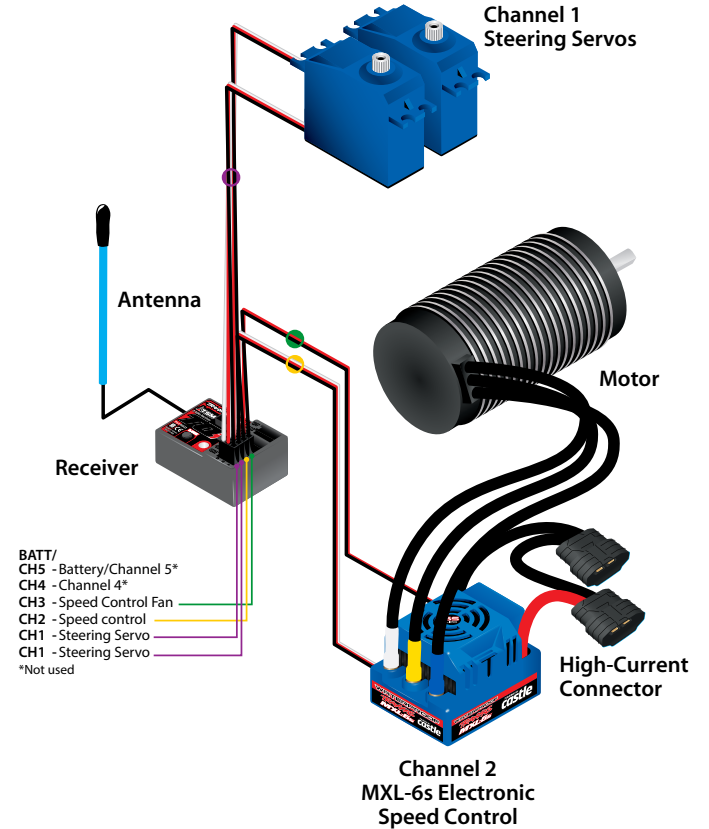

\*\*Accessory sensor expansion port for use with the Telemetry Expander Module (see Traxxas.com and materials included with your model for more information).

### INSTALLING TRANSMITTER BATTERIES

Your TQi transmitter uses 4 AA batteries. The battery compartment is located in the base of the transmitter.



1. Remove the battery compartment door by pressing the tab and sliding the door open.
2. Install the batteries in the correct orientation as indicated in the battery compartment.
3. Reinstall the battery door and snap it closed.
4. Turn on the transmitter and check the status indicator for a solid green light.

If the status LED flashes red, the transmitter batteries may be weak, discharged or possibly installed incorrectly. Replace with new batteries. The power indicator light does not indicate the charge level of the battery pack installed in the model. Refer to the Troubleshooting section on page 32 for more information on the transmitter Status LED codes.



### SELECTING BATTERIES FOR YOUR MODEL

Your model does not include batteries or a charger. Two NiMH or LiPo batteries equipped with Traxxas High-Current Connectors are required. LiPo batteries are recommended for best performance. Traxxas Power Cell batteries are strongly recommended for maximum performance. The following chart lists all the available Power Cell batteries for your model:

#### LiPo Batteries

2872X	5000mAh 11.1V 3-Cell 25C LiPO Battery
2843X	5800mAh 7.4V 2-Cell 25C LiPO Battery
2869X	7600mAh 7.4V 2-Cell 25C LiPO Battery

#### NiMH Batteries

2923X	Battery, Power Cell, 3000mAh (NiMH, 7-C flat, 8.4V)
2940X	Battery, Series 3 Power Cell, 3300mAh (NiMH, 7-C flat, 8.4V)
2950X	Battery, Series 4 Power Cell, 4200mAh (NiMH, 7-C flat, 8.4V)
2960X	Battery, Series 5 Power Cell, 5000mAh (NiMH, 7-C flat, 8.4V)

### SELECTING A CHARGER FOR YOUR MODEL

Make certain you choose the correct type of charger for the batteries you select. You MUST use a LiPo charger for LiPo batteries or battery damage with the potential for fire will result (see Warnings and Precautions for full details). Traxxas recommends you choose a genuine Traxxas EZ-Peak iD charger for easy charging and maximum battery life and performance.

Charger	Part Number	NiMH Compatible	LiPo Compatible	Battery iD
EZ-Peak Plus, 4-amp	2970	YES	YES	YES
EZ-Peak Dual, 8-amp	2972	YES	YES	YES



If the status LED doesn't light green, check the polarity of the batteries. If you see any other flashing signal from the LED, refer to the chart on page 32 to identify the code.



**Use the Right Batteries**  
Your transmitter uses AA batteries. Use new alkaline batteries (part #2914). Do not use rechargeable AA batteries to power the TQi transmitter, as they will not provide sufficient voltage for optimum transmitter performance.

**Caution:** Discontinue running your model at the first sign of weak batteries (flashing red light on the transmitter) to avoid losing control.





### Battery iD

Traxxas recommended battery packs are equipped with Traxxas Battery iD. This exclusive feature allows Traxxas battery chargers (sold separately) to automatically recognize connected battery packs and optimize the charge settings for the battery. This eliminates the need to worry over charger settings and menus for the easiest and safest charging solution possible. Visit [Traxxas.com](http://Traxxas.com) to learn more about this feature and available Traxxas iD chargers and batteries.



### The Traxxas High-Current Connector

Your model is equipped with the Traxxas High-Current Connector. Standard connectors restrict current flow and are not capable of delivering the power needed to maximize the output of the MXL-6s. The Traxxas connector's gold-plated terminals, with large contact surfaces, ensure positive current flow with the least amount of resistance. Secure, long-lasting, and easy to grip, the Traxxas connector is engineered to extract all the power your battery has to give.

## INSTALLING BATTERY PACKS

The E-Revo requires two fully charged battery packs (not included).

### Battery Installation

1. Open the battery compartment door by pressing on the release tabs.
2. Install the battery pack with the battery wires facing the rear of the model.
3. Make sure the battery is snug in the compartment. If not, remove battery and make adjustment to the battery retaining tab.
4. Route the battery wire through the slot near the vent.
5. Close the battery door, making sure not to pinch the battery wires. Be sure both release tabs are fully engaged with the door. Do not connect the battery packs to the ESC at this time. **Note:** Always unplug the batteries and remove from the model after use.

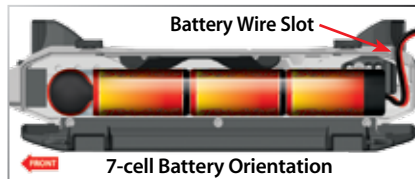
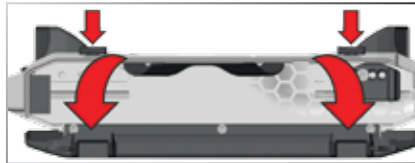

### Using Different Battery Configurations

The battery compartments in the E-Revo are adjustable to accommodate a large variety of battery packs. Depending on model, the battery compartments are configured at the factory to accept either 7-cell NiMH stick packs or 2-Cell LiPo battery packs. The E-Revo battery compartments have three key features for keeping your batteries secure:

1. A foam rubber cushion
2. A spring clip (This is removable for use with taller batteries.)
3. A battery retainer tab (This is adjustable to fit a variety of battery sizes.)

We recommend using this combination for all batteries. Make sure to adjust the battery retainer tab to keep your battery pack snug against the foam rubber cushion. This does not need to be very tight. It only needs to prevent the battery from moving excessively during use.

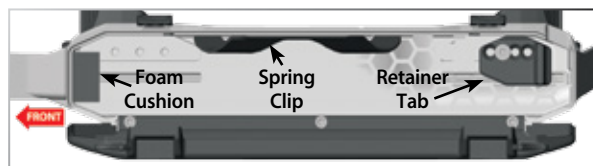

### 6-cell battery packs:

Swap the battery retainer tabs from the left and right battery compartments. This will provide additional adjustment needed to keep the 6-cell battery packs snug against the foam rubber cushions.

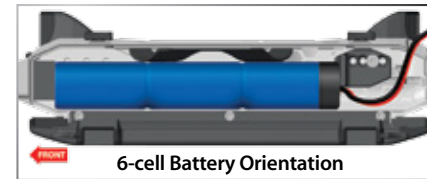

### Adjusting Battery Position

The best handling and performance is achieved when the batteries are positioned to the front of the battery compartment (against the foam rubber cushion); however, you can reposition the batteries to change the weight distribution and handling if desired. The E-Revo includes an extra set of battery retainer tabs that can be used in the front of the battery compartment to move the batteries toward the rear of the truck.

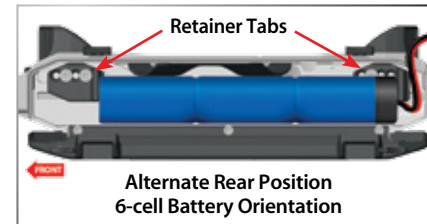

When using the battery retainer tabs in the front of the battery compartment, use two 3x10 countersunk cap screws to retain each battery retainer tab. **Do not use the battery retainer tabs in the front of the battery compartments when using LiPo batteries that are not in a hard plastic case.**

The battery compartments can be reconfigured to accept many sizes of LiPo batteries. If you are using batteries that are very thick, the spring clip may need to be removed from the battery compartment.

### Spring Clip Removal

1. Pull down on the inside of the clip.
2. Push the clip in toward the center of the model to release.

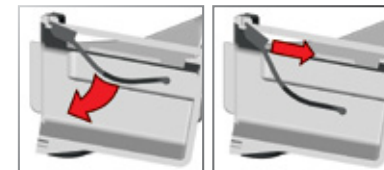



### Spring Clip Installation

1. Insert the two tabs on the spring clip into the rectangular tab slots in the chassis.
2. Rotate the spring clip upward.
3. Snap the tabs into place.

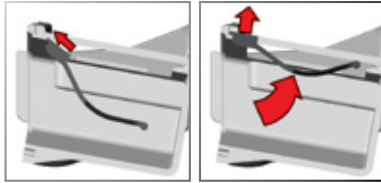

Many LiPo batteries do not use a hard plastic case. If using LiPo batteries that do not have a hard case, always be sure to use the foam rubber cushion in the front of the battery compartment. **Do not use the battery retainer tabs in the front of the battery compartments when using LiPo batteries that are not in a hard plastic case.** A hard front impact or crash when driving can damage the LiPo batteries.

### RADIO SYSTEM RULES

- Always turn your TQi transmitter on first and off last. This procedure will help to prevent your model from receiving stray signals from another transmitter, or other source, and running out of control. Your model has electronic failsafes to prevent this type of malfunction, but the first, best defense against a runaway model is to always turn the transmitter on first, and off last.

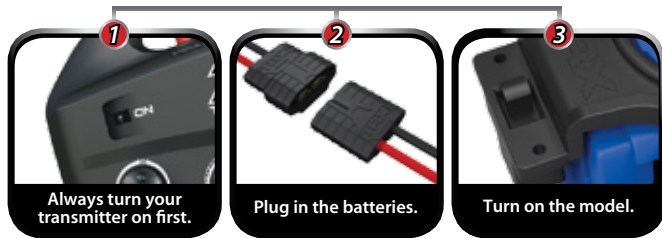

- Always use new batteries for the radio system. Weak batteries will limit the radio signal between the receiver and the transmitter. Loss of the radio signal can cause you to lose control of your model.
- In order for the transmitter and receiver to bind to one another, the receiver in the model must be turned on within 20 seconds of turning on the transmitter. The transmitter LED will flash fast red indicating a failure to link. If you miss it, simply turn off the transmitter and start over.
- Always turn on the transmitter before plugging in the battery.



### RADIO SYSTEM CONTROLS

### RADIO SYSTEM BASIC ADJUSTMENTS

#### Throttle Neutral Adjustment

The throttle neutral adjustment is located on the transmitter face and controls the forward/reverse travel of the throttle trigger. Change the adjustment by pressing the button and sliding it to the desired position. There are two settings available:



**50/50:** Allows equal travel for both acceleration and reverse.

**70/30:** Allows more throttle travel (70%) and less reverse travel (30%).

**Note:** We strongly recommend to leave this control in its factory location until you become familiar with all the adjustments and capabilities of your model. To change the throttle neutral adjust position, turn the transmitter off before adjusting the neutral position. **You will need to reprogram your electronic speed control to recognize the 70/30 setting.** Turn to page 16 for instructions.

#### Steering Trim

The electronic steering trim located on the face of the transmitter adjusts the neutral (center) point of the steering channel.



**Note:** Traxxas Stability Management (TSM) must be completely turned off while adjusting steering trim. See page 15 for TSM adjustments.



Remember, always turn the TQi transmitter on first and off last to avoid damage to your model.



Stop immediately at the first sign of weak batteries. Never turn the transmitter off when the battery pack is plugged in. The model could run out of control.



**Using Reverse:** While driving, push the throttle trigger forward to apply brakes. Once stopped, return the throttle trigger to neutral. Push the throttle trigger forward again to engage proportional reverse.



#### Automatic Failsafe

The TQi transmitter and receiver are equipped with an automatic failsafe system that does not require user programming. In the event of signal loss or interference, the throttle will return to neutral and the steering will hold its last commanded position. If failsafe activates while you are operating your model, determine the reason for signal loss and resolve the problem before operating your model again.

#### Multi-Function Knob

The Multi-Function knob can be programmed to control a variety of functions. From the factory, the Multi-Function knob controls Traxxas Stability Management (TSM). For more detail on TSM, refer to page 15.



#### USING THE RADIO SYSTEM

The TQi Radio System has been pre-adjusted at the factory. The adjustment should be checked before running the model, in case of movement during shipping. Here's how:

1. Turn the transmitter switch on. The status LED on the transmitter should be solid green (not flashing).
2. **Elevate the model on a block or a stand so that all the tires are off the ground.** Make sure your hands are clear of the moving parts of the model.
3. Plug the battery packs in the model into the speed control.
4. Switch the speed control on. You will hear a short sequence of tones as ALL the LEDs blink. The sequence will then repeat twice more, then the YELLOW LED will remain illuminated. **Always disconnect your batteries when the model is not in use.**
5. Turn the steering wheel on the transmitter back and forth and check for rapid operation of the steering servo. Also, check that the steering mechanism is not loose or binding. If the steering operates slowly, check for weak batteries.
6. When looking down at model, the front wheels should be pointing straight ahead. If the wheels are turned slightly to the left or right, turn off TSM (see page 15) and slowly adjust the steering trim control on the transmitter until they are pointing straight ahead; then, return the multi-function knob to the desired TSM setting.
7. Gently operate the throttle trigger to ensure that you have forward and reverse operation, and that the motor stops when the throttle trigger is at neutral. **Warning: Do not apply full throttle in forward or reverse while the model is elevated.**
8. Once adjustments are made, turn the model off first (using the switch on the speed control), then turn off the transmitter.

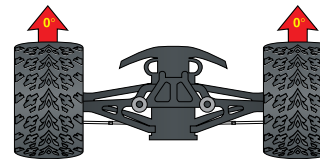

#### Range-Testing the Radio System

Before each running session with your model, you should range-test your radio system to ensure that it operates properly.

1. Turn on the radio system and check its operation as described in the previous section.
2. Have a friend hold the model. Make sure hands and clothing are clear of the wheels and other moving parts on the model.
3. Walk away from the model with the transmitter until you reach the farthest distance you plan to operate the model.
4. Operate the controls on the transmitter once again to be sure that the model responds correctly.
5. Do not attempt to operate the model if there is any problem with the radio system or any external interference with your radio signal at your location.

#### Higher Speeds Require Greater Distance

The faster you drive your model, the more quickly it will near the limit of radio range. At 60mph, a model can cover 88 feet every second! It's a thrill, but use caution to keep your model in range. If you want to see your model achieve its maximum speed, it is best to position yourself in the middle of the truck's running area, not the far end, so you drive the truck towards and past your position. In addition to maximizing the radio's range, this technique will keep your model closer to you, making it easier to see and control. **No matter how fast or far you drive your model, always leave adequate space between you, the model, and others. Never drive directly toward yourself or others.**

#### TQi Binding Instructions

For proper operation, the transmitter and receiver must be electronically 'bound.' **This has been done for you at the factory.** Should you ever need to re-bind the system or bind to an additional transmitter or receiver, follow these instructions. **Note:** The receiver must be connected to a 4.8-6.0v (nominal) power source for binding and the transmitter and receiver must be within 5 feet of each other.

1. Press and hold the transmitter's SET button as you switch the transmitter on. The transmitter's LED will flash red slowly. Release the SET button.
2. Press and hold the receiver's LINK button as you switch on the speed control by pressing the EZ-Set button. Release the LINK button.
3. When the transmitter and receiver's LEDs turn solid green, the system is bound and ready for use. Confirm that the steering and throttle operate properly before driving your model.

**TRAXXAS STABILITY MANAGEMENT (TSM)**



Traxxas Stability Management or TSM allows you to experience all the speed and acceleration that was engineered into your Traxxas model by helping you to maintain control of the vehicle

in low-traction situations. TSM helps provide straight ahead full-throttle acceleration on slippery surfaces, without fishtailing, spinouts, or loss of control. TSM also dramatically improves braking control. High speed cornering and control is also made possible as TSM makes corrections for you, without intruding on your fun, or creating unexpected side effects.

The Multi-Function knob on the TQi transmitter has been programmed to control TSM. The recommended (default) setting for TSM is to rotate the knob to the 12:00 position (the zero mark on the dial).



Turn the knob clockwise to increase assistance; turn the knob counterclockwise to decrease assistance. Turn the knob counterclockwise to its stop to turn TSM completely off.

**Note:** TSM is deactivated automatically when driving or braking in reverse.



When driving on surfaces with some traction, decrease the TSM setting to allow the vehicle to feel more "loose" for power sliding, drifting, and so on. On surfaces with very little traction (loose dirt, smooth concrete, ice/snow), increase TSM to maximize acceleration and control.

Drive with TSM on and off to test how it is making your control of the vehicle easier and more precise. For more information, visit [Traxxas.com/tsm](http://Traxxas.com/tsm).

**Note:** TSM must be completely turned off while adjusting steering trim.

**SETTING UP THE ANTENNA**

The receiver antenna has been set up and installed from the factory.

When reinstalling the antenna, first slide the antenna wire into the bottom of the antenna tube until the white tip of the antenna is at the top of the tube under the black cap. Insert the base of the tube into the antenna post. Take care not to crimp the antenna wire. Slide the crimp nut over the antenna tube and screw it onto the antenna post. Use the supplied tool to tighten the crimp nut on the post just until the antenna tube is securely in place. Do not overtighten or crush the antenna wire against the chassis. **Do not bend or kink the antenna wire! See the sidebar for more information. Do not shorten the antenna tube.**

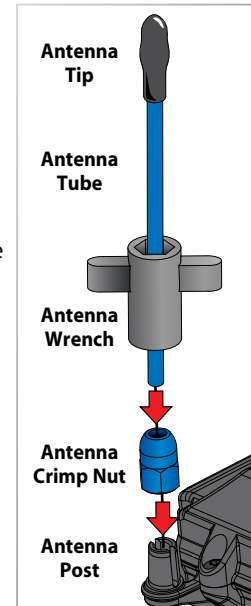

**!** To prevent loss of radio range do not kink or cut the black wire, do not bend or cut the metal tip, and do not bend or cut the white wire at the end of the metal tip.



### MXL-6s Specs

**Cells:**  
18 NiCad / NiMH 6s LiPo

**Resistance:**  
0.0003 Ohms per phase

**Brake :**  
Proportional with adjustable curve

**Reversible:**  
Yes - with lockout

**Low Voltage Cutoff:**  
Programmable

**Case Size:**  
2.2" x 1.9" x 1.4"

**Weight with Wires:**  
121g

**Connector Type:**  
6.5mm bullet

## ADJUSTING ELECTRONIC THE SPEED CONTROL

The MXL-6s electronic speed control should not need reprogramming with normal use; however, if you install a different radio system in your model, or change the transmitter's throttle-neutral setting from 50/50 to 70/30, you will need to reprogram the speed control. Follow these instructions to reprogram the speed control:

1. Install the batteries of your choice in the battery compartments and plug the batteries into the speed control.
2. Switch on your transmitter.
3. Hold full throttle while you switch on the MXL-6s controller. After a few seconds, you will hear multiple tones and the RED LED will light.
4. Hold full brake. After a few seconds, you will hear multiple tones and the YELLOW LED will light.
5. Release the trigger to the neutral position. After a few seconds, you will hear multiple tones and ALL THE LEDs will light.
6. Wait a few more seconds for the speed control to 'arm,' indicated by a double-tone. You are now ready to drive.

### Disconnect Batteries After Use

Always disconnect the batteries from the speed control when you are finished using your vehicle. The switch on the speed control only shuts off power to the receiver and servos. The speed control continues to draw power as long as it is plugged in and may over-discharge your batteries if they are left connected to the speed control.

## DRIVING YOUR MODEL

Now it's time to have some fun! This section contains instructions on driving and making adjustments to your model. Before you go on, here are some important precautions to keep in mind.

### • Make Sure The Axle Nuts Are Tight Before Each Run

Before operating your E-Revo Brushless Edition, take a moment to make sure the axle nuts are tight, as they may have loosened during shipping. The correct size axle-nut wrench is supplied with the truck. Check the tightness of the axle nuts before each run. The E-Revo's high speed and torque can loosen the nuts over time if left unchecked.

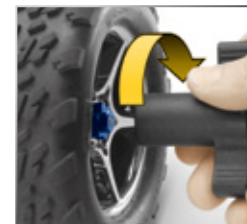

- Allow the model to cool for a few minutes between runs. This is particularly important when using high capacity battery packs that allow extended periods of running. Monitoring temperatures will extend the lives of the batteries and motors.
- Do not continue to operate the model with low batteries or you could lose control of it. Indications of low battery power include slow operation and sluggish servos (slow to return to center). Stop immediately at the first sign of weak batteries. When the batteries in the transmitter become weak, the red power light will begin to flash. Stop immediately and install new batteries.
- Do not drive the model at night, on public streets, or in large crowds of people.
- If the model becomes stuck against an object, do not continue to run the motors. Remove the obstruction before continuing. Do not push or pull objects with the model.
- Because the model is controlled by radio, it is subject to radio interference from many sources beyond your control. Since radio interference can cause momentary losses of control, allow a safety margin of space in all directions around the model in order to prevent collisions.
- Use good, common sense whenever you are driving your model. Intentionally driving in an abusive and rough manner will only result in poor performance and broken parts. Take care of your model so that you can enjoy it for a long time to come.
- High performance vehicles produce small vibrations which may loosen hardware over time. Frequently check wheel nuts and other screws on your vehicle to ensure that all hardware remains properly tightened.





### Slipper Clutch Break-In

The E-Revo Brushless Edition's slipper clutch requires a break-in procedure to ensure consistent operation with the extremely high power output of the included MXL-6s brushless motor system. The slipper clutch has been adjusted to the correct initial setting for break-in. Follow these steps to ensure maximum performance and life from your slipper clutch:

1. Make your first runs with the model using the stock gearing and 6- or 7-cell NiMH packs, or 2S LiPo packs.
2. Drive normally. The slipper clutch should slip momentarily when accelerating aggressively on high-traction surfaces (you will hear a whirring sound when the slipper clutch allows the spur gear to slip).
3. If excessive slippage is noticed (slipping that lasts for more than 3 seconds under hard acceleration), or the slipper clutch slips anytime the throttle is applied at any lever, stop driving immediately. Let the slipper clutch cool for 10-15 minutes. When the clutch is cool, test-drive the vehicle again. If you still experience excessive slippage, allow the slipper to cool once more, then tighten the slipper nut ¼ turn (turn the nut clockwise) and repeat the break-in process. Do not adjust the slipper clutch before it has cooled.
4. Continue to run the vehicle and monitor slipper clutch performance as noted above, and readjust if necessary. When the run is complete, the slipper should be fully broken in.

After break-in, the slipper clutch is ready for any type of driving, with any batteries up to 6S Lipo. Set the slipper clutch so it only slips for a moment (if at all) under hard acceleration in high-traction conditions. If excessive slippage is noticed, stop driving immediately. Continuing to drive with a loose slipper will cause damage to the slipper unit. You must let the slipper cool down to ambient temperature before tightening the slipper nut and resuming driving.

### About Run Time

A large factor affecting run time is the type and condition of your batteries. The milliamp hour (mAh) rating of the batteries determines how large their "fuel tank" is. A 3000mAh battery pack will theoretically run twice as long as a 1500mAh sport pack. Because of the wide variation in the types of batteries that are available and the methods with which they can be charged, it's impossible to give exact run times for the model.

Another major factor that affects run time is how the model is driven. Run times may decrease when the model is driven repetitively from a stop to top speed and with repetitive hard acceleration.

### Tips for Increasing Run Time

- Use batteries with the highest mAh rating you can purchase.
- Use a high-quality peak-detecting charger.
- Read and follow all maintenance and care instructions provided by the manufacturer of your batteries and charger.
- Keep the MXL-6s cool. Get plenty of airflow across the ESC.
- Lower your gear ratio. Installing smaller pinion gears will lower your gear ratio and cause less power draw from the motor and batteries, and reduce overall operating temperatures. Always replace both pinion gears together.
- Vary your speed. Continuous high-speed, high-gear running shortens the run time on the E-Revo.
- Maintain your model. Do not allow dirt or damaged parts to cause binding in the drivetrain. Keep the motor clean.

### mAh Ratings and Power Output

The mAh rating of the battery can effect your top-speed performance. The higher capacity battery packs experience less voltage drop under heavy load than low mAh rated packs. The higher voltage potential allows increased speed until the battery begins to become discharged.

### RUNNING IN WET CONDITIONS

Your new Traxxas model is designed with water-resistant features to protect the electronics in the model (receiver, servos, electronic speed control). This gives you the freedom to have fun driving your model through puddles, wet grass, snow, and through other wet conditions. Though highly water resistant, the model should not be treated as though it is submersible or totally 100% waterproof. Water resistance applies only to the installed electronic components. Running in wet conditions requires additional care and maintenance for the mechanical and electrical components to prevent corrosion of metal parts and maintain their proper function.

### Precautions

- Without proper care, some parts of your model can be seriously damaged due to contact with water. Know that additional maintenance procedures will be required after running in wet conditions in order to maintain the performance of your model. Do not run your model in wet conditions if you are not willing to accept the additional care and maintenance responsibilities.

- Not all batteries can be used in wet environments. Consult your battery manufacturer to see if their batteries can be used in wet conditions. Do not use LiPo batteries in wet conditions.
- The Traxxas TQi transmitter is not water resistant. Do not subject it to wet conditions such as rain.
- Do not operate your model during a rain storm or other inclement weather where lightning may be present.
- Do NOT allow your model to come in contact with salt water (ocean water), brackish water (between fresh water and ocean water), or other contaminated water. Salt water is highly conductive and highly corrosive. Use caution if you plan to run your model on or near a beach.

 **The cooling fan on the ESC is not water resistant. To avoid damaging the fan, it must be removed prior to driving your model in wet conditions. To remove the cooling fan:**

1. Remove the cover from the receiver box and unplug the connector.
2. Reinstall the receiver box cover.  
**Note: When reinstalling the receiver box cover, ensure that the O-ring is properly seated in the groove around the receiver box** (for more information, see "Receiver Box: Maintaining a Watertight Seal" on the page 19).
3. Remove the two 3x35mm cap screws from the ESC mount. Remove the ESC mount.
4. Release the two tabs on the side of the fan shroud to remove it from the ESC.
5. Remove the fan from the shroud.
6. Reinstall the shroud on the ESC.
7. Reinstall the ESC mount over the ESC. Secure the mount with the two 3x35mm cap screws.

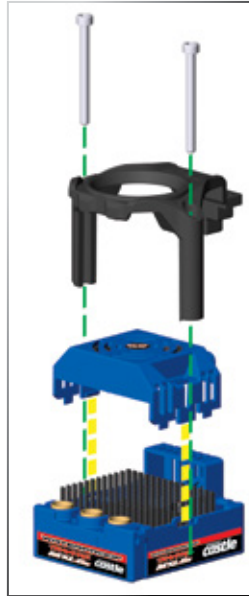

### Before Running Your Vehicle in Wet Conditions

1. Consult the section "After Running Your Vehicle in Wet Conditions" before proceeding. Make sure you understand the additional maintenance required with wet running.
2. The wheels have small holes molded in to allow air to enter and exit the tire during normal running. Water will enter these holes and get trapped inside the tires if holes are not cut in the tires. Cut two small holes (3mm or 1/8" diameter) in each tire. Each hole should be near the tire center-line, 180° apart.
3. Confirm that the receiver box O-ring and cover are installed correctly and secure. Make sure the screws are tight and the blue O-ring is not visibly protruding from the edge of the cover.
4. Confirm that your batteries can be used in wet conditions.
5. Use lower gearing (smaller pinion gears, as low as 9T or spur gear as large as 54T) when running in mud, deep puddles, snow, or other similar situations that will restrict the tires and put much higher loads on the motor.

### Motor Precautions

- Motor life can be greatly reduced in mud and water. If the motor gets excessively wet or submerged, use very light throttle (run the motor slowly) until the excess water can run out. Applying full throttle to a motor full of water can cause rapid motor failure. Your driving habits will determine motor life with a wet motor. Do not submerge the motor under water.
- Do not gear the motor by temperature when running in wet conditions. The motor will be cooled by water contact and will not give an accurate indication of appropriate gearing.
- Use special care when operating your model in muddy conditions. Stop operating your model if it appears to be straining due to the tackiness of the mud or build-up of mud on the chassis. Do not allow mud to collect on the motor or pack around the motor.

### After Running Your Vehicle in Wet Conditions

1. Drain the tires by spinning the tires at high speed to "sling" the water out. One way to do this is to make several high-speed passes on a flat, dry surface, if possible.
2. Remove the batteries.
3. Rinse excess dirt and mud off the truck with low-pressure water, such as from a garden hose. Do NOT use a pressure washer or other high pressure water. Avoid directing water into the bearings, differentials, etc.

4. Blow off the truck with compressed air (optional, but recommended). Wear safety glasses when using compressed air.
5. Remove the wheels from the truck.
6. Spray all the bearings, drivetrain, and fasteners with WD-40® or similar water displacing light oil.
7. Let the truck stand or you may blow it off with compressed air. Placing the truck in a warm, sunny spot will aid drying. Trapped water and oil will continue to drip from the truck for a few hours. Place it on a towel or piece of cardboard to protect the surface underneath.
8. As a precautionary step, remove the sealed receiver box cover. While unlikely, humidity or tiny amounts of moisture or condensation may enter the receiver box during wet running. This can cause long-term problems with the sensitive electronics in the receiver. Removing the receiver box cover during storage allows the air inside to dry. This step can improve the long-term reliability of the receiver. It is not necessary to remove the receiver or unplug any of the wires.
9. Additional Maintenance: Increase your frequency of disassembly, inspection, and lubrication of the following items. This is necessary after extended wet use or if the vehicle will not be used for an extended period of time (such as a week or longer). This additional maintenance is needed to prevent any trapped moisture from corroding internal steel components.
  - **Stub axle housing bearings:** Remove, clean, and re-oil the bearings.
  - **Differentials:** Remove, disassemble, clean, and re-grease the differential components. Use a light coating of wheel bearing grease (from an auto parts store) on the metal gear teeth. Refer to your exploded view diagrams for help with disassembly and reassembly.
  - **Motor:** After operating your model in wet or muddy conditions, remove the motor and clean any mud or dirt from the bearings. To access the rear bearing, remove the plastic cap with thumb pressure, or gently pry the cap off with a flat-blade screwdriver. To prevent corrosion and ensure maximum bearing life, lubricate the bearings with a light oil (available at your local hobby store). Following these steps will extend motor life and maintain peak performance. Be sure to wear eye protection when using spray aerosol cleaners.

## RECEIVER BOX: MAINTAINING A WATERTIGHT SEAL

### Removing and Installing Radio Gear

The unique design of the receiver box allows the removal and installation of the receiver without losing the ability to maintain a watertight seal in the box. The patent-pending wire clamp feature gives you the ability to also install aftermarket radio systems and maintain the watertight features of the receiver box.

### Removing the Receiver

1. To remove the cover, remove the two 3x10mm button-head cap screws.
2. To remove the receiver from the box, simply lift it out and set to the side. The antenna wire is still inside the clamp area and cannot be removed yet.
3. Remove the wire clamp by removing the two 2.8x8mm cap screws.
4. Unplug the servo cables from the receiver and remove the receiver.

### Receiver Installation

1. Always install the wires into the box before installing the receiver.
2. Install the antenna wire and the servo cables into the receiver box.
3. Arrange the wires neatly using the wire guides in the receiver box. The excess wire will be bundled inside the receiver box. Label which wire is for which channel.
4. Apply small bead of silicone grease (Traxxas part #1647) to the wire clamp.
5. Install the wire clamp and tighten the two 2.8x8mm cap screws securely.
6. Using double-sided adhesive foam tape, install the receiver into the box and plug the wires into receiver. Refer to page 10 for the wiring diagram.

**Note: For best performance, it is recommended that the receiver be installed in the original orientation as shown.**

7. Make sure the O-ring is properly seated into the groove in the receiver box so that the cover will not pinch it or damage it any way.
8. Install the cover and tighten the two 3x10mm button-head cap screws securely.
9. Inspect the cover to make sure that the O-ring seal is not visible.



## BASIC TUNING ADJUSTMENTS

This tuning and setup guide is separated into two sections- Basic and Advanced. E-Revo does not require any specialized knowledge or understanding of its unique suspension and drive train to perform typical, everyday setup and track tuning adjustments. Adjustment procedures for alignment, spring rate, damping, steering, and ride height are covered in the basic tuning section. Adjustments for the gear ratio, two-speed shift point, slipper clutch, and brake are also covered. In most cases, the basic information is all that is needed to tune E-Revo to perform well on a variety of surfaces.

E-Revo was engineered to provide sophisticated additional tuning options well beyond the basics that allow expert users to extract the maximum performance from the truck. The advanced tuning section (beginning on page 27) covers topics such as optional suspension rockers, roll center adjustment, caster adjustment, bump steer tuning, differential setup, and fine tuning the two-speed gear ratios. Make sure you fully understand the basic adjustments before experimenting with the advanced adjustments. Improper combinations of adjustments can adversely affect the performance of the truck, resulting in poor handling. If you don't know why you are changing an adjustment then you should leave it at its factory setting. Also included are instructions for using the Long-Travel rockers and springs supplied with E-Revo. The long travel rockers allow extreme suspension travel for rock crawling and rough, large-scale terrain. The long travel rockers allow the suspension to operate at its extreme mechanical limits and is recommended for advanced users.

### SUSPENSION TUNING

#### Springs

The front and rear springs on E-Revo have different spring rates. The rear springs are about 20% stiffer than the front springs. The spring's pre-load tension can be adjusted by turning the spring pre-load adjuster. Adjusting the pre-load changes the suspension sag. Suspension sag basically defines how much the suspension compresses when the truck is at rest. Adjust the pre-load so that the suspension compresses about one third of its full suspension travel (see illustration). If suspension sag is severe and requires a large increase of the spring pre-load to compensate, then a firmer spring should be used. Firmer springs (supplied) must be used when the Long Travel rocker arms are installed.

Use a stiffer spring to reduce sag, reduce body lean, control brake dive, and provide a firmer, more responsive overall feel. If E-Revo is

lightened significantly for racing applications, softer springs will be necessary to allow the suspension to sag properly. Heavier configurations will require stiffer springs. Ride height is adjusted by changing the length or position of the pushrods in the lower suspension arms. See the next section for ride height adjustments. The suspension sag and spring pre-load should be readjusted anytime the springs are removed and/or replaced.

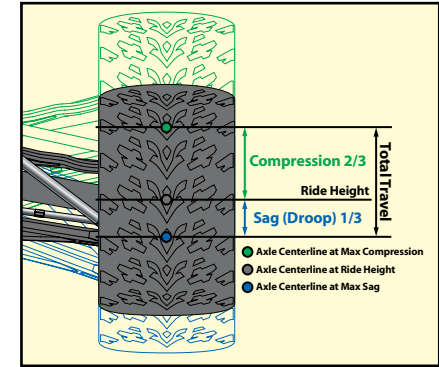

#### 90mm Travel

Dot Color	Spring Rate
● Yellow	14.8 lb/in (2.6 N/mm)
○ White	16.6 lb/in (2.9 N/mm) (Standard Front)
● Orange	18.3 lb/in (3.2 N/mm)
● Green	20.0 lb/in (3.5 N/mm) (Standard Rear)
● Gold	21.7 lb/in (3.8 N/mm)
○ Tan	23.4 lb/in (4.1 N/mm)
● Black	25.1 lb/in (4.4 N/mm)

#### 120mm Travel

Dot Color	Spring Rate
○ Silver	28.0 lb/in (4.9 N/mm) (Standard Front)
● Pink	30.8 lb/in (5.4 N/mm)
● Blue	33.7 lb/in (5.9 N/mm) (Standard Rear)
● Purple	36.5 lb/in (6.4 N/mm)

**Note:** 90mm Travel springs are not recommended for use with the Long Travel Rockers.

#### Ride Height Adjustment

The rocker arm suspension uses push rods on each suspension arm. Changing the length and/or position of the push rod adjusts the ride height without affecting or compromising other suspension parameters. For example, you can raise and lower the ride height without changing up/down travel distribution, changing springs, or affecting your progressive rate. This feature is unique to E-Revo and is extremely beneficial in a racing environment where you can achieve a low center of gravity (by lowering the ride height) without losing any suspension capability. Increasing the ride height will increase ground clearance for rough terrain.



The ride height of the model can be changed by mounting the push rod in a different hole in the lower suspension arm.

From the factory, the push rod comes installed in the center hole of the lower suspension arm's push rod mount. If the push rod is mounted in the inner hole, the ride height of the vehicle increases. If mounted in the outer hole, the ride height decreases.

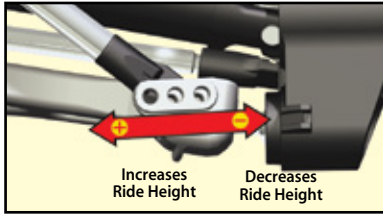

The ride height can be finely tuned by adjusting the sag of the suspension. **Do not attempt to make large changes to the ride height by adjusting the spring pre-load on the shock bodies.** If suspension sag is severe and requires a large increase of the spring pre-load to compensate, then a firmer spring should be used. The lowest ride height can be achieved by installing the optional adjustable push rod in the outermost hole of the lower suspension arm's push rod mount. Turn the rod ends all the way in until they stop (shortening the length).

The optional Long Travel rocker arms are designed to be used only with the standard non-adjustable push rods installed in the hole labeled "LT" (the middle hole of the lower suspension arm's push rod mount). Any minor adjustments to the ride height are accomplished by adjusting the spring pre-load.

#### Adjusting the Pivot Ball Caps

The pivot ball caps should be adjusted so that the pivot balls operate freely in the axle carriers with no excess play. Use the provided four-way suspension multi-tool to tighten or loosen the pivot ball cap.

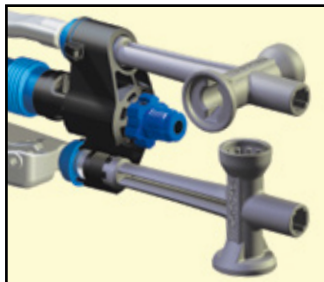

#### Shock Oil

The 4 oil-filled aluminum shocks (dampers) effectively control the suspension movement by preventing the wheels and tires from continuing to "bounce" after rebounding from a bump. Changing the oil in the shocks can vary the suspension damping effect. Changing the oil to a higher viscosity oil will increase damping. Lowering the viscosity

of the oil will cause the suspension damping to be reduced. Damping should be increased (with higher viscosity oil) if the model is bottoming easily over jumps. Damping should be decreased (with thinner viscosity oil) if the model is hopping over small bumps and feels unstable. The viscosity of shock oil is affected by extremes in operating temperature; an oil of certain viscosity will become less viscous at higher temperatures and more viscous at lower temperatures. Operating in regions with cold temperatures may require lower viscosity oil. From the factory, the shocks are filled with SAE-40W silicone oil. Only use 100% silicone oil in the shock.

For shock piston tuning see *Advanced Tuning Adjustments* on page 27.

#### Replacing Shock Oil

The shocks have to be removed from the vehicle and disassembled to change the oil.



1. Remove the lower spring retainer and shock spring.
2. Remove the upper shock cap using the shock wrench and the suspension multi tool
3. Empty the used shock oil from the shock body.
4. Fill the shock with new silicone shock oil up to the top of the shock body.
5. Slowly move the piston up and down (always keeping it submerged in oil) to release the air bubbles. Let the shock sit for a few minutes to allow any remaining air bubbles to surface.
6. Slowly thread the upper cap with the installed shock bladder onto the shock body with the suspension multi tool. The excess oil will bleed out of the small hole in the shock cap.
7. Tighten the shock cap until snug. Use the included steel shock wrench to hold onto shock body while tightening.



**Important:** The shocks are assembled at the factory with a center-to-center distance (between the rod end balls) of 87mm. Any time the shocks are removed and disassembled, this distance should be checked to ensure proper operation of the suspension.

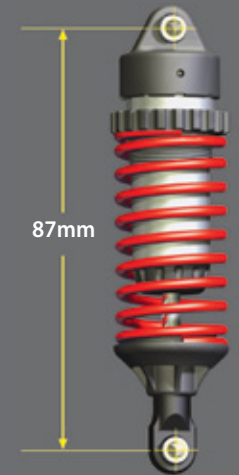



For caster, roll center, and optional rocker arm tuning see *Advanced Tuning Adjustments* on page 27.



A camber gauge (available at your local hobby shop) can be a useful tool for alignment setting.



All of the toe links are installed on the truck so that the left hand thread indicators point to the same direction. This makes it easier to remember which way to turn the wrench to increase or decrease toe link length (the direction is same at all four corners). Note that the groove in the hex indicates the side of the toe link with the left-hand threads.

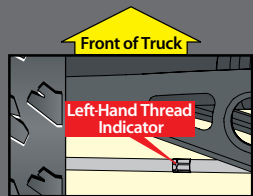

Left Front

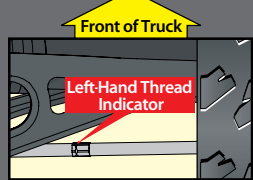

Right Front

### ALIGNMENT SETTINGS

The alignment settings are critical for optimizing the performance of E-Revo. Adjust your alignment as carefully and precisely as you possibly can.

#### Toe Adjustment

The wheels can be adjusted to point straight ahead or have a toe-in or toe-out setting. To help you remember, look down at your feet. For toe-in, your feet point towards each other. For toe-out, your feet point away from each other.

The toe angle of the front wheels can be adjusted by varying the length of the toe links that connect the steering linkage to the front axle carriers. The toe angle of the rear wheels can be adjusted by varying the length of the metal toe links that connect the rear bulkheads to the rear axle carriers. The front toe links and rear toe links are equipped with turnbuckles. The lengths of the toe links can be adjusted by turning them with the included 5mm Traxxas wrench.

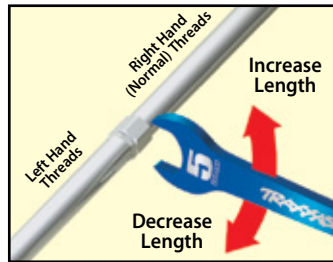
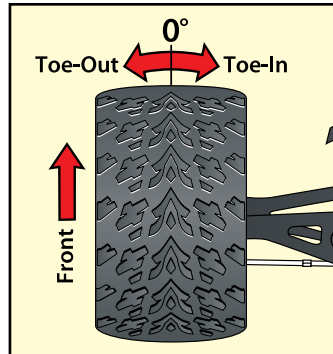

#### Toe Base Factory Settings

**Front:** 0-degrees

**Rear:** 1-degree toe-in each side

Under certain conditions, toe-in can be increased to a maximum of 3 degrees. To avoid potential interference of suspension components with the long travel rockers installed, see the maximum alignment limits table on page 23.

#### Static Camber Adjustment

The wheels can be set to have either positive or negative camber (see illustration below). The camber angle changes as the wheel moves up and down through its range of travel. Static camber is the camber angle at the wheel when the vehicle is set at its normal, stationary ride height.

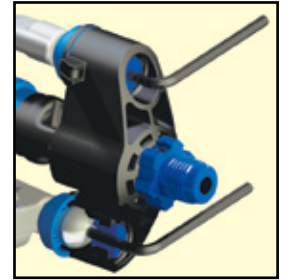

The suspension pivot balls located in the axle carriers adjust the static camber. The pivot balls are protected by blue dust plugs. To adjust your static camber, insert the supplied 2.5 mm hex wrench through the slit in the dust plug and engage the end of the pivot ball (compressing the suspension until the arms are parallel to the ground will allow for easier hex wrench engagement). The upper pivot ball is normally screwed all the way in. Negative camber is achieved by screwing the pivot ball of the lower control arm out. **Note:** When camber is changed, the toe angle of the wheel has to be reset.

#### Static Camber Base Factory Settings

**Front:** 1-degree negative camber each side

**Rear:** 1-degree negative camber each side

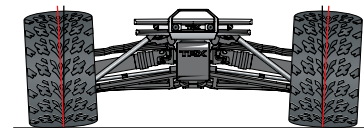

Positive camber

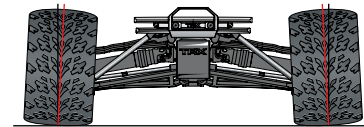

Negative camber

**Maximum Alignment Limits (using stock push rod length)**

E-Revo’s maximum toe and camber alignment settings can be limited by the ride height setting. Do not exceed the maximum limits or you could experience interference between suspension components. The ride height is controlled by where the push rod is installed in the lower suspension arm. First determine which of the following configurations you are using:

- a. **Stock Configuration** – When the pushrod is in the middle position of the lower control arm.
- b. **Raised Configuration** - When the pushrod is in the raised position to increase the vehicle’s ride height (innermost hole in lower control arm).
- c. **Lowered Configuration** - When the pushrod is in the lowered position to decrease the vehicle’s ride height (outermost hole in lower control arm).
- d. **Long Travel Configuration** – When the pushrod is in the middle position of the lower control arm with the Long Travel rockers installed.

**Front Suspension**

The following are suggested maximum settings for the front suspension in order to avoid interference between suspension components:

Configuration	Available Camber (degrees)	Available Toe (degrees)	
		Toe In	Toe Out
Stock	+3 to -5	3	3
Raised	+3 to -1	1	1
Lowered	+3 to -5	3	3
Long travel	+3 to -1	1	1

**Rear Suspension**

The following are suggested maximum settings for the rear suspension for all configurations. Toe out is not normally used on the rear of E-Revo.

Configuration	Available Camber (degrees)	Available Toe (degrees)	
		Toe In	Toe Out
All	+3 to -5	3	2

**TRANSMISSION TUNING**

**Adjusting the Slipper Clutch**

The E-Revo is equipped with an adjustable Torque Control slipper clutch which is built into the large spur gear. The purpose of the slipper clutch is to regulate the amount of power sent to the rear wheels to prevent tire spin. When it slips, the slipper clutch makes a high-pitch, whining noise.

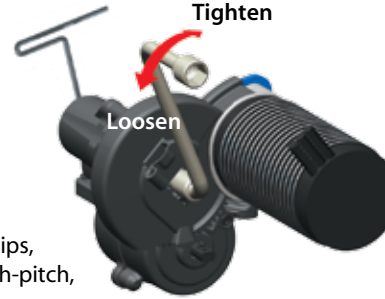

The slipper clutch is integrated into the main spur gear on the transmission. The slipper clutch is adjusted using the spring-loaded locknut on the slipper shaft. Use the supplied universal wrench. To tighten or loosen the slipper nut, insert the 2.0mm hex wrench into the hole in the end of the slipper shaft. This locks the shaft for adjustments. Turn the adjustment nut clockwise to tighten (less slippage) and counter-clockwise to loosen (more slippage).

**WHEELS AND TIRES**

Many types of aftermarket tires and wheels can be adapted for use on your model. Most will affect the overall width and the suspension geometry of the model. The offsets and dimensions designed into the model’s wheels are intentional; therefore, Traxxas cannot recommend the use of other non-Traxxas wheels with different specifications. The diameter of the wheels is an innovative design, and there is a variety of different tires available for you to experiment with in addition to the included tires on the model (listed in your parts list). Experimentation with different types of tires is recommended to see which ones work the best on the terrain where the model is run. When selecting tires, consider the overall diameter and the rubber compound (hard or soft). If the overall diameter of the tire is significantly increased, you will need to use a smaller pinion gear to compensate for the larger tire. Soft compound tires with many short spikes generally work better on hard, dry surfaces. In loose dirt, a tire with large spikes should perform better. See your parts list for accessory wheels and tires.

**i** To achieve a good starting point for the slipper clutch, tighten the slipper clutch adjusting nut clockwise until the slipper clutch adjusting spring fully collapses (do not over tighten), and then turn the slipper clutch nut counter-clockwise ¼ to ½ turn.

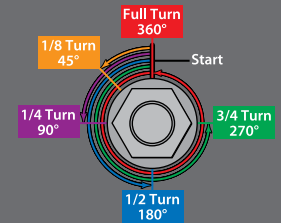

**Gearing Compatibility Chart:**

The chart below shows a full range of gear combinations. This does NOT imply that these gear combinations should be used. Over-gearing (bigger pinions, smaller spurs) can overheat and damage the motor and/or speed control.

Spur Gear

	54	56	58	62	65	68
12	4.50	4.67	4.83	5.17	5.42	5.67
13	4.15	4.31	4.46	4.77	5.00	5.23
14	3.86	4.00	4.14	4.43	4.64	4.86
15	3.60	3.73	3.87	4.13	4.33	4.53
16	3.38	3.50	3.63	3.88	4.06	4.25
17	3.18	3.29	3.41	3.65	3.82	4.00
18	3.00	3.11	3.22	3.44	3.61	3.78
19	NR	NR	3.05	3.26	3.42	3.58
20	NR	NR	NR	3.10	3.25	3.40
21	NR	NR	NR	NR	3.10	3.24
22	NR	NR	NR	NR	NR	3.09
23	NR	NR	NR	NR	NR	DNF
24	NR	NR	NR	NR	NR	DNF
25	NR	NR	NR	NR	NR	DNF

Pinion Gear

- B Stock gearing
- B Optional included gearing (4S LiPo)
- Recommended gearing for all battery types
- Recommended gearing for 4S LiPo only
- Not recommended
- Does not fit

**MOTORS AND GEARING**

**CAUTION: Read before operating your model with 65+mph gearing!**

- The 24/54 ratio for use with 6S LiPo batteries is designed for maximum speed on smooth surfaces only, with steady acceleration to full throttle.
- Do not use this gear ratio for general driving.
- Avoid repetitive starting and stopping.
- Do not use the 24/54 ratio with NiMH batteries or low-capacity LiPo batteries. 5000mAh LiPo batteries are recommended.
- Allow the motor to cool between runs, and monitor motor temperature.
- Do not use the 24/54 gear ratio for off-road running or overheating and damage may result.
- Do not allow the motor temperature to exceed 200° F or damage and motor failure may result. To accurately monitor motor temperature and prevent overheating, a telemetry temperature sensor (part #6521, sold separately) can be installed on the motor to continually monitor temperature as your drive.

**Adjusting Gear Mesh**

Incorrect gear mesh is the most common cause of stripped spur gears. Gear mesh should be checked and adjusted anytime a gear is replaced. Access the gears by removing the single screw on the top gear cover.

To set the gear mesh, cut a narrow strip of notebook paper and run it into the gear mesh of the motor. The motor is mounted to an aluminum motor mount. Loosen the single motor mount screw with the provided 3mm wrench to slide the motor and pinion gear into the spur gear. Retighten the motor mount screw and then remove the strip of paper. You should be able to run a fresh strip of paper through the gears without binding them.

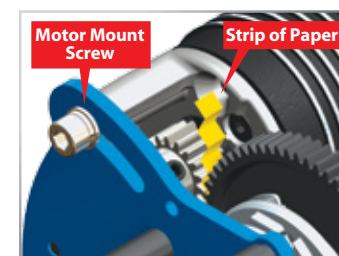
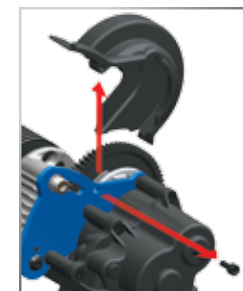

Model #56086-4

Your Battery Selection and Pinion Gear Selection Determines Your Speed.

**How Fast Do You Want To Go?**

Speed	35+ mph	40+ mph*	50+ mph	65 mph & Beyond
Pinion/Spur	18/65	18/54	18/65	24/54**
Battery	Twin 7-Cell NiMH (14 cell total)	Twin 2S LiPo (4S total)	Twin 3S LiPo (6S total)	Twin 3S LiPo (6S total)
Nominal Voltage	16.8V	14.8V	22.2V	22.2V
mAh	4000+ mAh	5000+ mAh	5000+ mAh	5000+ mAh
Skill Level				

\*with included optional gearing  
\*\*optional gearing (not included)

## DUAL SERVO STEERING SYSTEM

E-Revo uses dual-servo steering and a single heavy-duty servo saver for powerful, responsive steering. To prevent unnecessary receiver battery drain it is important to make sure that the servos are “at rest” when the steering is at neutral. If one servo is out of adjustment, then both servos will work against each other, fighting to find center.

### Adjusting The Steering System

1. Remove the servo horns and steering links from the servos.  
Disconnect the steering links from the servo saver.

2. Adjust both the steering links to be the exact same length (31.7mm - use “Steering Link Length Template” to set length).

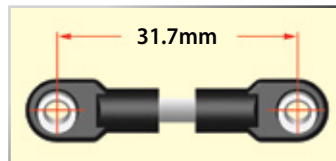

Steering Link Length Template

3. Switch on the power to the receiver and the transmitter.
4. Turn off TSM (see page 15).
5. Adjust the steering trim on the transmitter to the neutral “0” position.

6. Connect one end of a steering link to the steering servo saver arm and the other end to the servo horn.
7. Position the steering servo saver arm perpendicular to the centerline of the vehicle.

8. While holding the steering servo saver arm in the position mentioned in step 6, install the servo horn onto the servo such that the steering link is parallel with the centerline of the vehicle. This will automatically set the servo horn at the 7-degree offset shown in the illustration.

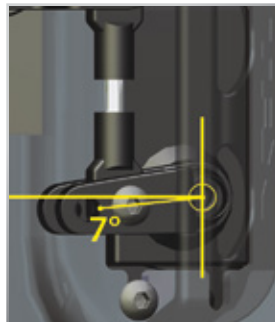

9. Install the second servo horn on the other side following the same procedure.

If necessary, fine-tune the length of the second steering link to eliminate any load on the steering system in the neutral position. If you are using aftermarket servos, it is important to use servo horns designed for E-Revo. Optional steering servo horns are sold separately for use with non-Traxxas servos.

### Servo Saver Tuning

An optional stiffer spring is available for the servo saver when using servos with metal gear sets (see parts list for details). Do not use this spring with standard Traxxas high-torque servos.

### Maximum Travel Steering (optional)

The stock E-Revo steering system provides a good balance between steering sensitivity and turning radius. E-Revo includes an optional maximum travel steering stop which can be installed for maximum steering throw, which may be desired in racing applications. This provides sharper turning at low speeds, but also makes the steering more sensitive at high speeds.



Maximum Travel Steering Stop

To increase the steering throw, replace the stock steering stop with the included maximum travel steering stop on the model. This part has modified steering stops to allow increased travel. Once installed, reposition the steering links to the outer holes on both steering servo horns. Refer to the exploded views included with the model to assist installation.



Stock Steering System

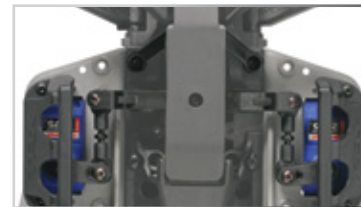

Maximum Travel System Installed

If you have questions or need technical assistance, call Traxxas at

**1-888-TRAXXAS**

(1-888-872-9927) (U.S. residents only)



## MAINTAINING YOUR MODEL



Always wear eye protection when using compressed air or spray cleaners and lubricants.

Your model requires timely maintenance in order to stay in top running condition. **The following procedures should be taken very seriously.**

### Inspect the vehicle for obvious damage or wear. Look for:

1. Cracked, bent, or damaged parts
2. Check the wheels and steering for binding.
3. Check the operation of the shock absorbers.
4. Check the wiring for any frayed wires or loose connections.
5. Check the mounting of the receiver and servo(s) and speed control.
6. Check the tightness of the wheel nuts with a wrench.
7. Check the operation of the radio system, especially the condition of the batteries.
8. Check for any loose screws in the chassis structure or suspension.
9. Inspect the gears for wear, broken teeth, or debris lodged between the teeth.
10. Check the tightness of the slipper clutch.
11. Check the tightness of the front pivot balls.

### Other periodic maintenance:

#### • Slipper clutch pads (friction material):

Under normal use, the friction material in the slipper clutch should wear very slowly. If the thickness of any one of the slipper clutch pads is 1.8mm or less, the friction disc should be replaced. Measure the pad thickness using calipers or measuring against the diameter of the 1.5 and 2.0mm hex wrenches provided with the model.



- **Chassis:** Keep the chassis clean of accumulated dirt and grime. Periodically inspect the chassis for damage.

- **Motors:** Every 10-15 runs, remove, clean, and lubricate the motors. Use a product such as electric motor cleaning spray to flush dirt out of the motors. After cleaning, lubricate the bushings at each end of the motors with a drop of light-weight electric motor oil.
- **Shocks:** Keep the oil level in the shocks full. Use only 100% pure silicone shock oil to prolong the life of the seals. If you are experiencing leakage around the top of the shock, inspect the bladder in the top cap for signs of damage or distortion from overtightening. If the bottom of the shock is leaking, then it is time for a rebuild. The Traxxas rebuild kit for two shocks is part #5462.
- **Suspension:** Periodically inspect the model for signs of damage such as bent or dirty suspension pins, bent turnbuckles, loose screws, and any signs of stress or bending. Replace components as needed.
- **Driveline:** Inspect the driveline for signs of wear such as worn drive yokes, dirty axle half shafts, and any unusual noise or binding. Remove the gear cover and inspect the spur gear for wear and check the tightness of set screws in the pinion gears. Tighten, clean, or replace components as needed.

### Storage

When you are through running the model for the day, blow it off with compressed air or use a soft bristled paint brush to dust-off the vehicle. Always disconnect and remove the batteries from the model whenever the model is stored. If the model will be stored for a long time, then also remove the batteries from the transmitter.

## ADVANCED TUNING ADJUSTMENTS

This advanced tuning guide will take you one step further into the cutting edge technology that has been designed into E-Revo. Follow the instructions provided here to take advantage of E-Revo's maximum performance potential.

### SUSPENSION AND ALIGNMENT SETTINGS

#### Caster Adjustment

The caster angle of the front suspension may be used to adjust the understeer (push)/oversteer handling characteristics of the model. Generally, increasing the caster angle will move the truck towards an oversteer condition (more traction on the front tires, less on the rear tires). Decreasing the caster angle will create a tendency towards understeer (pushing in the turns). From the factory, the front suspension is set to a caster angle of 10-degrees. The rear caster angle is not adjustable. The caster angle of the front suspension can be adjusted from 5° to 15°. Adjust the caster by positioning the caster adjustment shims on the upper control arms of the front suspension as shown in the table to the right.

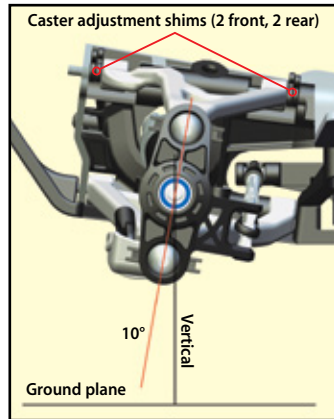

Number & Position of Caster Adjustment Shims (Front Upper Control Arm)

Caster	In Front of Hinge Pin Boss	Behind Hinge Pin Boss
5.0°	None	Four
7.5°	One	Three
10.0°	Two	Two
12.5°	Three	One
15.0°	Four	None

#### Caster Angle, and Bump Steer

Bump steer is unwanted change in the steering angle of the front wheels as the suspension travels up and down. It can result in unstable and unpredictable handling. Bump steer is affected by the position of the outer toe link end on the axle carrier. From the factory, the toe links are positioned so that bump steer is virtually eliminated (about 3/100 of a degree through the entire range of travel). When the caster angle is changed, the outer toe link end should be repositioned on the axle carrier to maintain zero bump steer geometry. Adjustment is achieved using the shims and hollow balls provided with the vehicle. Refer to the Bump Steer Elimination chart on page 28, and look up your caster angle setting to find the correct position for the outer toe links. Positioning the toe-links correctly will maintain the original factory geometry and eliminate the unwanted steering angle changes caused by bump steer.

#### Roll Center

There are two holes on the bulkheads to mount each upper suspension arm. The roll center of the vehicle can be raised by mounting the upper control arm in the lower of the two holes. This will effectively increase the roll stiffness of the vehicle (similar to installing swaybars). Adding roll resistance to one end of the vehicle will tend to add traction to the opposite end. For example, increasing roll resistance in the rear by installing the upper arms in the lower holes will provide more traction for the front wheels and potentially more steering. Installing the upper arms in the lower holes on the front and rear will increase overall roll resistance without changing the handling balance. The arms are installed in the upper position from the factory to make the truck easier and more forgiving to drive and less likely to traction roll in turns. The lower holes should be reserved for track tuning. **Note:** When the upper suspension arms are moved to the lower holes, the front outer toe link ends and the rear toe control links should be repositioned to eliminate bump steer. Refer to the Bump Steer Elimination chart on page 28, and look up your suspension combination (caster angle and roll center position) to find the correct position for the front outer toe links and the rear toe control links. Adjustment is achieved using the shims and hollow balls provided with the vehicle.

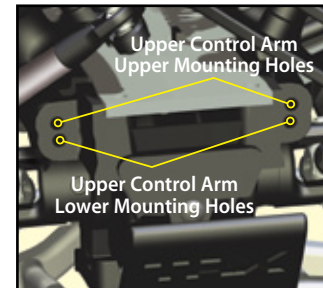

#### Rockers (Progressive Rate/ Suspension Travel)

One of the most exciting aspects of E-Revo's suspension is the inboard shock (damper) arrangement that uses pivoting rockers to translate vertical wheel travel into linear shock motion. The rockers can be changed to increase or decrease the maximum wheel travel and also to change the progressive rate of the suspension.

The progressive rate determines how much the force at the wheel produced by the springs being compressed (wheel force) will vary with suspension travel (or vertical travel of the wheel). On a progressive suspension arrangement, the wheel force will increase at a faster and faster rate as the suspension is compressed. It feels as though the shock spring gets progressively stiffer the more you compress the suspension. On a linear suspension arrangement, the wheel force increases linearly as the suspension is compressed. The spring does not feel any stiffer, even when the suspension is fully compressed. This provides a very "push" feeling suspension with seemingly bottomless suspension travel.



When using Long Travel rockers, a correspondingly thicker shock oil (or pistons with smaller diameter bypass holes) should also be used to ensure a proper relationship between the spring and damping forces.

Rocker Arm	Total Travel	Progressive Rate
Progressive 1	90mm (60mm up / 30mm down)	Low
Progressive 2	90mm (60mm up / 30mm down)	Medium
Progressive 3	90mm (60mm up / 30mm down)	High
Long Travel	120mm (80mm up / 40mm down)	Low

A total of four different rocker arm sets are available for E-Revo. All rocker arms except the Long Travel rocker arms will allow the wheel to travel a total of 90mm in the vertical direction. From the ride height position, the wheel will be able to travel 60mm in the upward direction (bump), and 30mm in the downward direction (droop). The Long Travel rocker arm increases total travel to 120mm. The progressive rate can be increased or decreased by installing different rocker arm sets. The rockers are labeled Progressive 1 to Progressive 3. Progressive 1 rockers will provide a low progressive rate that maintains consistent damping force across through the whole range of suspension travel. These are best for extremely rough terrain that requires maximum suspension articulation. Progressive 3 rockers use high progressive rate that will improve high-speed cornering on smooth surfaces by providing a firmer feel. Body roll, brake dive and rear squat will also be reduced. Always change all four rockers as a complete set. Do not mix rates and travel.

Using rockers with lower progressive rate may require the use of stiffer springs to maintain proper spring pre-load and ride height. The spring pre-load adjuster on each shock is designed for minor adjustments. If the adjuster needs to be turned all the way down (compressing the spring) in order to maintain proper ride height, then the next stiffer spring should be used.

The chart below demonstrate the effect of the various rocker arms on wheel force as the suspension is compressed. On the progressive rate, wheel force is light at first and increases as the suspension is compressed.

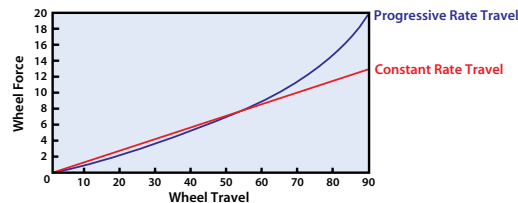

**Bump Steer Elimination Chart**

The illustrations and the following table detail the position of the outer toe link end for various caster and roll center settings to eliminate bump steer. The shims and the hollow balls used to adjust bump steer are provided with your vehicle.

**FRONT**

Outer Toe Link End Setup	Caster					Control Arm Mounting Hole on Front Bulkhead
	5°	7.5°	10°	12.5°	15°	
Standard Hollow Ball					⊙	Upper
Thin Shim						
Thick Shim				⊙		Lower
Thin Shim						
Standard Hollow Ball				⊙		Upper
Thick Shim						
Tall Center Hollow Ball				⊙		Upper
		⊙				Lower
Thick Shim						
Standard Hollow Ball						
Thin Shim	⊙					Lower
Thick Shim						
Thin Shim						
Standard Hollow Ball	⊙					Upper

**REAR**

When the rear upper control arms are mounted in the lower of its two mounting holes in the bulkhead (roll center), the tall hollow ball should be used as shown.

Outer Toe Link End Setup	Control Arm Mounting Hole on Rear Bulkhead
Tall Lower Hollow Ball	Upper
Tall Center Hollow Ball (stock)	Lower

## SHOCK TUNING

### Shock Pistons

The shock pistons can be replaced with the available optional pistons to vary the amount of damping. Optional pistons with bypass holes that are larger or smaller (1, 2, or 3) than the factory installed stock pistons can be used to decrease or increase damping respectively. Change the pistons if you only have one weight of shock oil available to you. From the factory, E-Revo is equipped with #1 pistons in the front and #2 pistons in the rear.

### Shock disassembly

The shocks must be removed from the vehicle and disassembled to change the pistons. Use the shock exploded views included with the model to aid in the assembly process.

1. Remove the spring and lower spring retainer from the shock.
2. Remove the shock cap (A) and empty the shock body of shock oil.
3. Remove the lower cap (B) and the X-ring from the shock body.
4. Use side cutters to grip the shock shaft just above the rod end (C). Remove the rod end from the shock shaft using the suspension multi-tool (C).
5. Remove the shock shaft with piston from the shock body out through the top of the shock body.

### Shock assembly

1. Replace the stock piston with desired optional piston. Be careful not to lose the small washer located below the piston.
2. Position the new piston onto the shock shaft above the small washer. Grip the threads of

#### Multi-tool Shock Functions



A. Tighten/Loosen Upper Cap



B. Tighten/Loosen Lower Cap



C. Remove/Install Rod End



Piston Installation/Removal

the shaft with side cutters or needlenose pliers and tighten the nut with the 4-way wrench to secure the assembly.

3. Insert the shock shaft assembly through the shock body until the piston bottoms out.
4. Lubricate the shaft and X-ring with silicone oil.
5. Install the X-ring over the shaft and into the bore of the shock body.
6. Install the lower cap using the suspension multi-tool (B).
7. Slide the bump stop onto the shaft.
8. Grip the shaft close to the threads with needle nose pliers or side cutters and thread the rod end onto the shock shaft until the rod end bottoms out (C).
9. Fill the shock with new silicone shock oil up to the top of the shock body. Slowly move the piston up and down (always keeping it submerged in oil) to release the air bubbles. Let the shock sit for a few minutes to allow any remaining air bubbles to surface.
10. Slowly thread the upper cap with the installed shock bladder onto the shock body with the suspension multi tool (A). The excess oil will bleed out of the small hole in the shock cap. Tighten the shock cap until snug. Use the included steel shock wrench to hold onto shock body while tightening.
11. Reinstall the spring and lower retainer.

### Tuning The Sealed Gear Differentials

E-Revo's front and rear gear differentials allow the left and right wheels to spin at different speeds while turning so that the tires do not scuff or skid. This decreases the turning radius and increases steering performance.

The performance of the differentials can be tuned for different driving conditions and performance requirements. The differentials are filled with silicone differential fluid, and are sealed to maintain consistent long-term performance. Changing the oil in the differential with either lower or higher viscosity oil will vary the performance characteristics of the differentials. Changing to a higher viscosity oil in the differential will reduce the tendency for engine power to be transferred to the wheel with the least traction. You may notice this when making sharp turns on slick surfaces. The unloaded wheels on the inside of the turn have the least traction and tend to spin up to extremely high rpms. Higher viscosity (thicker) oil causes the differential to act like a limited-slip differential, distributing more equal power to the left and right wheels. E-Revo will generally benefit from higher viscosity oil when climbing,

### Shock Piston Hole Sizes

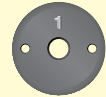

Piston 1: 1.10 mm

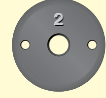

Piston 2: 1.00 mm

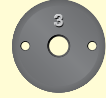

Piston 3: 0.95 mm



Never slide the threads on the shock rod past the X-ring seal when it is installed and compressed by the bottom cap of the shock. Doing so will damage the seal and cause shock oil to leak.



**Use higher viscosity (thicker) differential oil for:**

- More power to the wheels with the most traction.
- Racing on low-traction smooth surfaces.
- Better performance for climbing on uneven terrain.

**Using lower viscosity (thinner) differential oil for:**

- More power to the wheels with least traction.
- Racing on low-traction rough surfaces.

rock crawling, or racing on low traction surfaces. **Note:** Heavier oil will allow power to be transferred even with one or more tires off the ground. This can make the vehicle more likely to overturn.

From the factory, both the differentials are filled with SAE 30,000W viscosity silicone oil. Only use silicone oil in the differentials. Traxxas sells SAE 10,000W and SAE 50,000W viscosity oil (see your parts list). The differentials have to be removed from the vehicle and disassembled to change/replace oil.

**Installing the Long Travel Rockers**

Use the exploded views included with the model to aid in the installation process. All of the rockers have labels identifying their proper location; RF (right front), LF (left front), RR (right rear), and LR (left rear). **Note:** *The exhaust system must be removed to access the rear rocker arms.*

**1. Remove shock absorbers**

Remove the screws that secure the shocks to the chassis shock mounts, and to the rocker arms.

**2. Install long travel shock springs**

Replace all four of the 90mm travel shock springs with the four 120mm long travel shock springs. The front shock springs are indicated by a silver dot, and the rear shock springs are indicated by a blue dot.

**3. Install long travel rockers**

Replace the 90mm travel rockers with the long travel rockers by removing the four 4x6mm buttonhead cap screws from the rocker pivot posts. Remove the 5x11 ball bearings from the rockers. Install the same 5x11 ball bearings in the long travel rockers. Secure the long travel rockers to the pivots with the same 4x6mm buttonhead cap screws.

**4. Locate push rods**

Make sure that all four of the suspension push rods are located and secured into the middle position (marked LT) on the lower suspension arms.

**5. Reinstall shock absorbers**

Reinstall all four shock absorbers back into their respective locations.

**MOTOR INSTALLATION**

To access the motor, remove the gear cover by removing the single screw on the top of the gear cover. The motor uses an aluminum mount for quick, easy motor access and gearing adjustment. To remove the motor, remove the single large hex screw using the supplied 3mm wrench; then, rotate the motor and mount to the side of the model, and slide backward off the post.

The motor mount was carefully engineering to provide additional features and adjustability. Two sets of holes are provided for use with aftermarket motors. These use 3mm screws with 25mm spacing that is compatible with most aftermarket motors. These are:

1. Low CG (center of gravity) installation (mounts the motor low to the chassis for best handling performance)
2. High CG installation (mounts motor higher for more clearance for larger motors or aftermarket heat sinks)

An additional set of motor mounting holes is included for custom application. This is for larger aftermarket motors with 4mm screws and 29 - 30mm spacing.

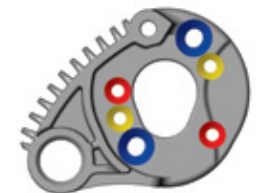
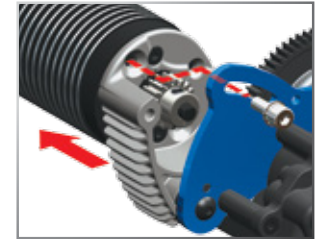

- Low CG
- High CG
- Big Motors

If you have questions or need technical assistance, call Traxxas at

**1-888-TRAXXAS**

(1-888-872-9927) (U.S. residents only)



Your Traxxas transmitter has a programmable Multi-Function knob that can be set to control various advanced transmitter functions (set to Traxxas Stability Management (TSM) by default, see page 15). Accessing the programming menu is done by using the menu and set buttons on the transmitter and observing signals from the LED. An explanation of the menu structure follows on page 34. Experiment with the settings and features to see if they can improve your driving experience.

## Steering Sensitivity (Exponential)

The Multi-Function knob on the TQi transmitter can be set to control Steering Sensitivity (also known as exponential). The standard setting for Steering Sensitivity is “normal (zero exponential),” with the dial full left in its range of travel. This setting provides linear servo response: the steering servo’s movement will correspond exactly with the input from the transmitter’s steering wheel. Turning the knob clockwise from center will result in “negative exponential” and decrease steering sensitivity by making the servo less responsive near neutral, with increasing sensitivity as the servo nears the limits of its travel range. The farther you turn the knob, the more pronounced the change in steering servo movement will be. The term “exponential” comes from this effect; the servo’s travel changes exponentially relative to the input from the steering wheel. The exponential effect is indicated as a percentage—the greater the percentage, the greater the effect. The illustrations below show how this works.

### Normal Steering Sensitivity (0% exponential):

In this illustration, the steering servo’s travel (and with it, the steering motion of the model’s front wheels) corresponds precisely with the steering wheel. The ranges are exaggerated for illustrative purposes.

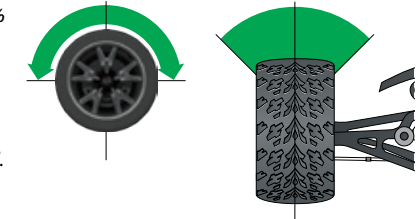

### Decreased Steering Sensitivity (Negative Exponential):

By turning the Multi-Function knob clockwise, the steering sensitivity of the model will be decreased. Note that a relatively large amount of steering wheel travel results in a smaller amount of servo travel. The farther you turn the knob, the more pronounced the effect becomes. Decreased steering sensitivity may be helpful when driving on low-traction surfaces, when driving at high speed, or on tracks that favor sweeping turns where gentle steering inputs are required. The ranges are exaggerated for illustrative purposes.

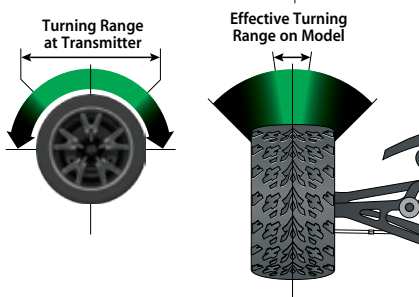

## Throttle Sensitivity (Throttle Exponential)

The Multi-Function knob can be set to control Throttle Sensitivity. Throttle Sensitivity works the same way as Steering Sensitivity, but applies the effect to the throttle channel. Only forward throttle is affected; brake/reverse travel remains linear regardless of the Throttle Sensitivity setting.

## Steering Percentage (Dual-Rate)

The Multi-Function knob can be set to control the amount (percentage) of servo travel applied to steering. Turning the Multi-Function knob fully clockwise will deliver maximum steering throw; turning the knob counterclockwise reduces steering throw (note: turning the dial counterclockwise to its stop will eliminate all servo travel). Be aware that the steering End Point settings define the servo’s maximum steering throw. If you set Steering Percentage to 100% (by turning the Multi-Function knob fully clockwise), the servo will travel all the way to its selected end point, but not past it. Many racers set Dual-Rate so they have only as much steering throw as they need for the track’s tightest turn, thus making the model easier to drive throughout the rest of the course. Reducing steering throw can also be useful in making a model easier to control on high-traction surfaces, and limiting steering output for oval racing where large amounts of steering travel are not required.

## Braking Percentage

The Multi-Function knob may also be set to control the amount of brake travel applied by the servo in a nitro-powered model. Electric models do not have a servo-operated brake, but the Braking Percentage function still operates the same way in electric models. Turning the Multi-Function knob full clockwise will deliver maximum brake throw; turning the knob counterclockwise reduces brake throw (**Note:** Turning the dial counterclockwise to its stop will eliminate all brake action).

## Throttle Trim

Setting the Multi-Function knob to serve as throttle trim will allow you to adjust the throttle’s neutral position to prevent unwanted brake drag or throttle application when the transmitter trigger is at neutral. **Note:** Your transmitter is equipped with a Throttle Trim Seek mode to prevent accidental runaways. See the sidebar for more information.



### Starting Over: Restoring Factory Defaults

When programming your TQi transmitter, you may feel the need to start over with a clean slate. Follow these simple steps to restore the factory settings:

1. Turn transmitter off.
2. Hold both MENU and SET.
3. Turn transmitter on.
4. Release MENU and SET. The transmitter LED will blink red.
5. Press MENU once. The transmitter LED will blink red twice repeatedly.
6. Press SET to clear settings. The LED will turn solid green and the transmitter is restored to default.



### Throttle Trim Seek Mode

When the Multi-Function knob is set to throttle trim, the transmitter remembers the throttle trim setting. If the throttle trim knob is moved from the original setting while the transmitter is off, or while the transmitter was used to control another model, the transmitter ignores the actual position of the trim knob. This prevents the model from accidentally running away. The LED on the face of the transmitter will rapidly blink green and the throttle trim knob (Multi-Function knob) will not adjust the trim until it is moved back to its original position saved in memory. To restore throttle trim control, simply turn the multi-function knob either direction until the LED stops blinking.

**Failsafe**

Your Traxxas radio system is equipped with a built-in failsafe function that returns the throttle to its last saved neutral position in the event of a signal loss. The LED on the transmitter and the receiver will rapidly flash red.

**Steering and Throttle End Points**

The TQi transmitter allows you to choose the limit of the servo's travel range (or its "end point") independently for left and right travel (on the steering channel) and throttle/brake travel (on the throttle channel). This allows you to fine-tune the servo settings to prevent binding caused by the servo moving steering or throttle linkages (in the case of a nitro model) farther than their mechanical limits. The end point adjustment settings you select will represent what you wish to be the servo's maximum travel; the Steering Percentage or Braking Percentage functions will not override the End Point settings.

**Steering and Throttle Sub-Trim**

The Sub-Trim function is used to precisely set the neutral point of the steering or throttle servo in the event that simply setting the trim knob to "zero" does not completely center the servo. When selected, Sub-Trim allows finer adjustment to the servo output shaft's position for precise setting of the neutral point. Always set the Steering Trim knob to zero before making final adjustment (if required) using Sub-Trim. If Throttle Trim has been previously adjusted, the Throttle Trim will need to be reprogrammed to "zero" before making final adjustment using Sub-Trim.









**Setting Lock**

Once you've adjusted all of these settings the way you like them, you may want to disable the Multi-Function knob so none of your settings can be changed. This is especially handy if you operate multiple vehicles with a single transmitter via Traxxas Link™ Model Memory.



**Multiple Settings and the Multi-Function Knob**

It is important to note that settings made with the Multi-Function knob are "overlaid" on top of each other. For example, if you assign the Multi-Function to adjust Steering Percentage and set it for 50%, then reassign the knob to control Steering Sensitivity, the transmitter will "remember" the Steering Percentage setting. Adjustments you make to Steering Sensitivity will be applied to the 50% steering throw setting you selected previously. Likewise, setting the Multi-Function knob to "disabled" will prevent the knob from making further adjustments, but the last setting of the Multi-Function knob will still apply.

**TRANSMITTER LED CODES**

LED Color / Pattern	Name	Notes
 Solid green	Normal Driving Mode	See page 13 for information on how to use your transmitter controls.
 Slow red (0.5 sec on / 0.5 sec off)	Binding	See page 14 for more information on binding.
 Flashing fast green (0.1 sec on / 0.15 sec off)	Throttle Trim Seek Mode	Turn the Multi Function knob right or left until the LED stops flashing. See sidebar for more information.
 Flashing medium red (0.25 sec on / 0.25 sec off)	Low Battery Alarm	Put new batteries in the transmitter. See page 11 for more information.
 Flashing fast red (0.125 sec on / 0.125 sec off)	Link Failure / Error	Transmitter and receiver are no longer bound. Turn the system off and then back on to resume normal operation. Find source of the link failure (ie out of range, low batteries, damaged antenna).
<b>Programming Patterns</b>		
 Counts out number (green or red) then pauses	Current menu position	See Menu Tree for more information.
 Fast green 8 times	Menu setting accepted (on SET)	
 Fast red 8 times	Menu SET invalid	User error such as trying to delete a locked model.

**RECEIVER LED CODES**

LED Color / Pattern	Name	Notes
 Solid green	Normal Driving Mode	See page 13 for information on how to use your transmitter controls.
 Slow red (0.5 sec on / 0.5 sec off)	Binding	See page 14 for more information on binding.
 Flashing fast red (0.125 sec on / 0.125 sec off)	Failsafe / Low Voltage Detect	Consistent Low Voltage in the receiver triggers failsafe so there is enough power to center the throttle servo before it completely loses power.

## TRAXXAS LINK MODEL MEMORY

Traxxas Link Model Memory is an exclusive, patent-pending feature of the TQi transmitter. Each time the transmitter is bound to a new receiver, it saves that receiver in its memory, along with all the settings assigned to that receiver. When the transmitter and any bound receiver are switched on, the transmitter automatically recalls the settings for that receiver. There is no need to manually select your vehicle from a list of model memory entries.

### Model Lock

The Traxxas Link Model Memory feature can store up to thirty models (receivers) in its memory. If you bind a thirty-first receiver, Traxxas Link Model Memory will delete the “oldest” receiver from its memory (in other words, the model you used the longest time ago will be deleted). Activating Model Lock will lock the receiver in memory so it cannot be deleted.

You may also bind multiple TQi transmitters to the same model, making it possible to pick up any transmitter and any previously bound model in your collection and simply turn them on and drive. With Traxxas Link Model Memory, there is no need to remember which transmitter goes with which model, and there is never a need to have to select any model from a list of model memory entries. The transmitter and receiver do it all for you automatically.

### To activate Model Lock:

1. Switch on the transmitter and receiver you wish to lock.
2. Press and hold MENU. Release when the status LED blinks green.
3. Press MENU three times. The status LED will blink green four times repeatedly.
4. Press SET. The status LED will blink green in single-flash intervals.
5. Press SET once. The status LED will blink red once repeatedly.
6. Press MENU once. The status LED will blink red twice repeatedly.
7. Press SET. The LED will blink rapidly green. The memory is now locked. Press and hold MENU to return to driving mode.

**Note:** To unlock a memory, press SET twice at step 5. The LED will blink rapidly green to indicate the model is unlocked. To unlock all models, press MENU twice at step 6 and then press SET.

### To delete a model:

At some point, you may wish to delete a model you no-longer drive from the memory.

1. Switch on the transmitter and receiver you wish to delete.
2. Press and hold MENU. Release when the status LED blinks green.
3. Press MENU three times. The status LED will blink green four times repeatedly.
4. Press SET once. The status LED will blink green once repeatedly.
5. Press MENU once. The status LED will blink green twice repeatedly.
6. Press SET. The memory is now selected to be deleted. Press SET to delete the model. Press and hold MENU to return to driving mode.

**MENU TREE**

The Menu Tree below shows how to navigate through the TQi transmitter's various settings and functions. Press and hold MENU to enter the Menu Tree, and use the following commands to navigate through the menu and select options.

**MENU:** When you enter a menu, you always start at the top. Press MENU to move down the Menu Tree. When you reach the bottom of the tree, pressing MENU again will return you to the top.

**SET:** Press SET to move across the Menu Tree and select options. When an option is committed to the transmitter's memory, the status LED will rapidly blink green.

**BACK:** Press both MENU and SET to go back one level in the Menu Tree.

**EXIT:** Press and hold MENU to exit programming. Your selected options will be saved.

**ECHO:** Press and hold SET to activate the "echo" function. Echo will "play back" your current position on the Menu Tree should you lose your place. For example: If your current position is Steering Channel End Points, holding SET will cause the LED to blink green twice, green once, and then red three times. Echo will not alter your adjustments or change your position in the programming sequence.

Below is an example of how to access a function in the Menu Tree. In the example, the user is setting the Multi-Function knob to be a Steering % (Dual-Rate) control.

- To set the Multi-Function knob to control STEERING % (DUAL-RATE):

  1. Switch the transmitter on.
  2. Press and hold MENU until the green LED lights. It will blink in single intervals.
  3. Press SET. The red LED will blink in single intervals to indicate Steering Sensitivity (Expo) has been selected.
  4. Press MENU twice. The red LED will blink three times repeatedly to indicate Steering % (Dual-Rate) has been selected.
  5. Press SET to select. The green LED will blink 8 times fast to indicate successful selection.
  6. Press and hold MENU to return to driving mode.

**Restoring Factory Defaults:**

Transmitter OFF	Hold both MENU and SET	Transmitter ON	Release MENU and SET red LED blinks	Press SET to clear settings. LED will turn solid green. Transmitter is restored to default
-----------------	------------------------	----------------	----------------------------------------	--------------------------------------------------------------------------------------------

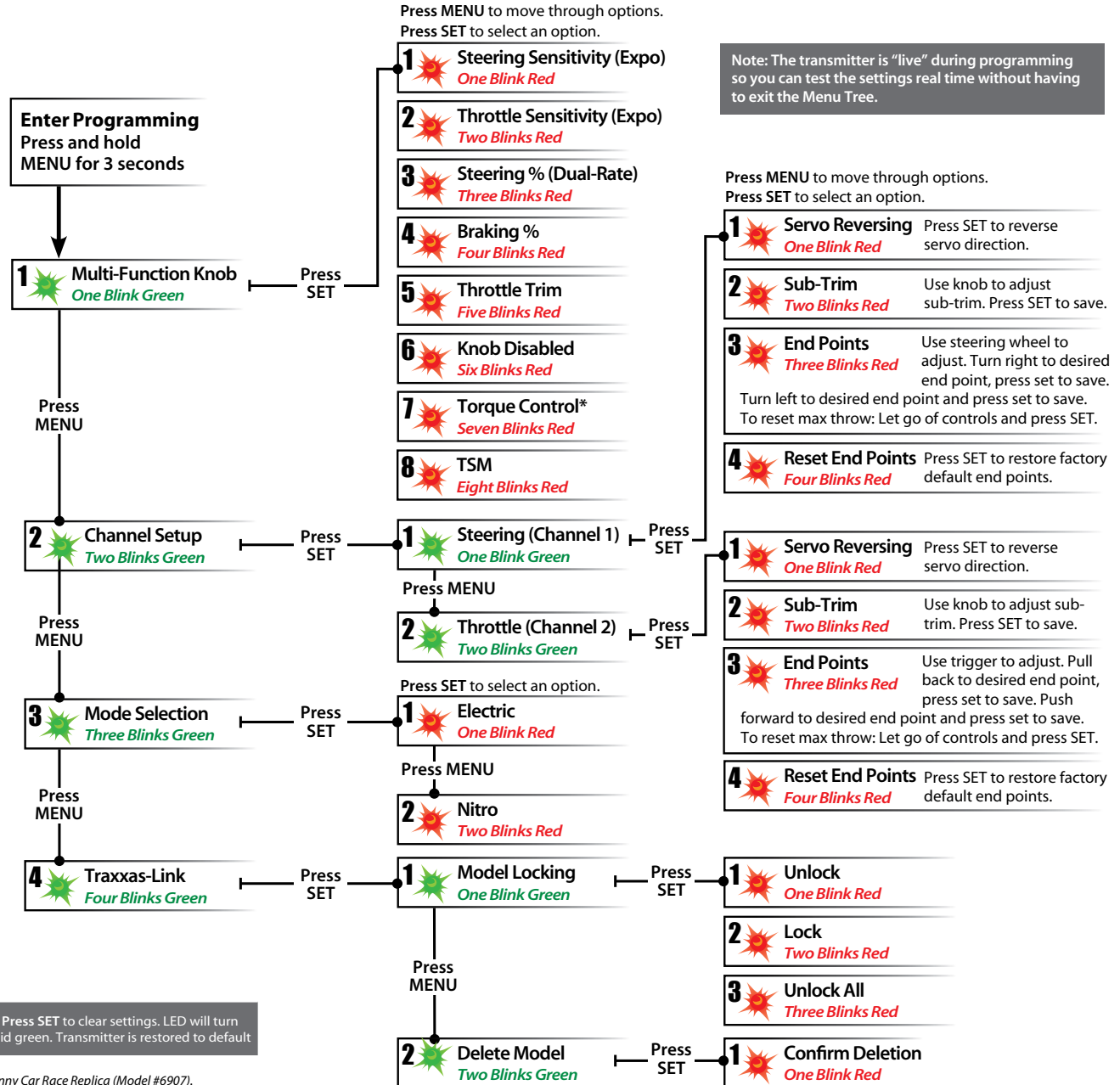

\*Torque Control is a feature designed only for use with the power system in the Traxxas Funny Car Race Replica (Model #6907).

Set Multi-Function knob for STEERING SENSITIVITY (Expo)	Press/hold MENU green LED blinks	Press SET red LED blinks	Press SET to confirm green LED blinks (x8)	Press/hold MENU returns to driving mode						
Set Multi-Function knob for THROTTLE SENSITIVITY (Expo)	Press/hold MENU green LED blinks	Press SET red LED blinks	Press MENU to confirm red LED blinks (x2)	Press SET to select green LED blinks (x8)	Press/hold MENU returns to driving mode					
Set Multi-Function knob for STEERING DUAL RATE (%)	Press/hold MENU green LED blinks	Press SET red LED blinks	Press MENU twice red LED blinks (x3)	Press SET to select green LED blinks (x8)	Press/hold MENU returns to driving mode					
Set Multi-Function knob for BRAKING PERCENTAGE (%)	Press/hold MENU green LED blinks	Press SET red LED blinks	Press MENU 3 times red LED blinks (x4)	Press SET to select green LED blinks (x8)	Press/hold MENU returns to driving mode					
Set Multi-Function knob for THROTTLE TRIM	Press/hold MENU green LED blinks	Press SET red LED blinks	Press MENU 4 times red LED blinks (x5)	Press SET to select green LED blinks (x8)	Press/hold MENU returns to driving mode	Adjust the Multi-Function knob until the LED turns solid green.				
To LOCK the Multi-Function knob	Press/hold MENU green LED blinks	Press SET red LED blinks	Press MENU 5 times red LED blinks (x6)	Press SET to lock green LED blinks (x8)	Press/hold MENU returns to driving mode					
To REVERSE the direction of STEERING servo	Press/hold MENU green LED blinks	Press MENU green LED blinks (x2)	Press SET green LED blinks	Press SET red LED blinks	Press SET to reverse servo direction	Press/hold MENU returns to driving mode				
To set the SUB TRIM of the STEERING servo	Press/hold MENU green LED blinks	Press MENU green LED blinks (x2)	Press SET green LED blinks	Press SET red LED blinks	Press MENU red LED blinks (x2)	Use Multi-Function knob to set neutral	Press SET to save position	Press/hold MENU returns to driving mode		
To set the END POINTS of the STEERING servo	Press/hold MENU green LED blinks	Press MENU green LED blinks (x2)	Press SET green LED blinks	Press SET red LED blinks	Press MENU twice red LED blinks (x3)	Turn steering wheel to desired max left and right travel	Press SET to save each position	Turn steering wheel to test settings	IF END POINTS ARE OK: Press/hold MENU returns to driving mode	IF END POINTS NEED TO BE CHANGED: Press SET and repeat steps 6-8
To reset the END POINTS of STEERING servo to defaults	Press/hold MENU green LED blinks	Press MENU green LED blinks (x2)	Press SET green LED blinks	Press SET red LED blinks	Press MENU 3 times red LED blinks (x4)	Press SET to reset end points	Press/hold MENU returns to driving mode			
To REVERSE the direction of THROTTLE servo	Press/hold MENU green LED blinks	Press MENU green LED blinks (x2)	Press SET green LED blinks	Press MENU green LED blinks (x2)	Press SET red LED blinks	Press SET to reverse servo direction	Press/hold MENU returns to driving mode			
To set the SUB TRIM of the THROTTLE servo	Press/hold MENU green LED blinks	Press MENU green LED blinks (x2)	Press SET green LED blinks	Press MENU green LED blinks (x2)	Press SET red LED blinks	Press MENU red LED blinks (x2)	Use Multi-Function knob to set neutral	Press SET to save position	Press/hold MENU returns to driving mode	
To set the END POINTS of the THROTTLE servo	Press/hold MENU green LED blinks	Press MENU green LED blinks (x2)	Press SET green LED blinks	Press MENU green LED blinks (x2)	Press SET red LED blinks	Press MENU twice red LED blinks (x3)	Use throttle trigger to set desired max throttle or brake	Press SET to save Use trigger to test	IF END POINTS ARE OK: Press/hold MENU returns to driving mode	IF END POINTS NEED TO BE CHANGED: Press SET and repeat steps 7-9
To reset the END POINTS of THROTTLE servo to defaults	Press/hold MENU green LED blinks	Press MENU green LED blinks (x2)	Press SET green LED blinks	Press MENU green LED blinks (x2)	Press SET red LED blinks	Press MENU 3 times red LED blinks (x4)	Press SET green LED blinks (x8)	Press/hold MENU returns to driving mode		

MENU TREE FORMULAS

To select functions and make adjustments to the TQi transmitter without referencing the menu tree, turn your transmitter on, find the function in the left column you wish to adjust, and simply follow the corresponding steps.



Always turn your transmitter on first.





The Traxxas Link Wireless Module is sold separately (part #6511). The Traxxas Link application is available from the Apple App store for iPhone, iPad, or iPod touch and on Google Play for Android devices. iPhone, iPad, iPod touch, or the Android device are not included with the Traxxas Link Wireless Module.

For more information about the Traxxas Link Wireless Module and the Traxxas Link application, visit [Traxxas.com](http://Traxxas.com).

## PROGRAMMING YOUR TQi TRANSMITTER WITH YOUR APPLE IPHONE, IPAD, IPOD TOUCH, OR ANDROID MOBILE DEVICE

The Traxxas Link™ Wireless Module (part #6511, sold separately) for the TQi transmitter installs in minutes to transform your Apple® iPhone®, iPad®, iPod touch®, or Android™ device into a powerful tuning tool that allows you to replace the transmitter's button/LED programming system with an intuitive, high-definition, full-color graphical user interface.



### Traxxas Link

The powerful Traxxas Link app (available in the Apple App Store™ or on Google Play™) gives you complete control over the operation and tuning of your Traxxas model with stunning visuals and absolute precision. Install Traxxas Link telemetry sensors on the model, and Traxxas Link displays real-time data such as speed, RPM, temperature, and battery voltage.



Compatible with:  
iPod touch (5th generation and later)  
iPad (3rd generation and later)  
iPad mini  
Android 4.4 (and later)

iPhone 4S  
iPhone 5  
iPhone 5C  
iPhone 5S

Intuitive iPhone, iPad, iPod touch, and Android interface Traxxas Link makes it easy to learn, understand, and access powerful tuning options. Control Drive Effects settings such as TSM assistance percentage; steering and throttle sensitivity; steering percentage; braking strength; and throttle trim by simply touching and dragging the sliders on the screen.

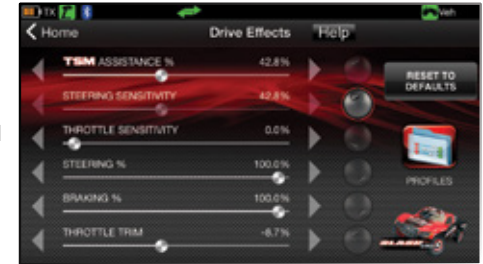

Tap and slide to adjust TSM, Steering Sensitivity, Throttle Trim, Braking Percent, and more!

### Real-Time Telemetry

When you equip your model with sensors, the Traxxas Link dashboard comes to life showing you speed, battery voltage, RPM, and temperature. Set threshold warnings and log maximums, minimums, or averages. Use the recording function to document your dashboard view, with sound, so that you can keep your eyes on your driving and not miss a single apex.

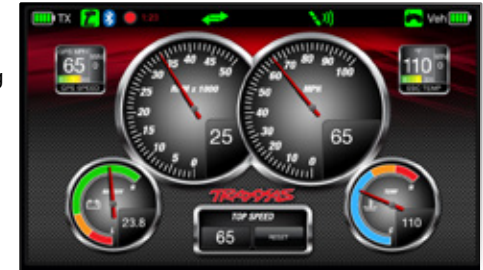

The customizable Traxxas Link dashboard delivers real-time rpm, speed, temperature, and voltage data.

### Manage up to 30 Models with Traxxas Link

The TQi radio system automatically keeps track of what vehicles it has bound to and what settings were used for each—up to 30 models total! Traxxas Link provides a visual interface to name the models, customize their settings, attach profiles, and lock them into memory. Simply choose a model and any previously bound transmitter, power them up, and start having fun.



Traxxas Link Model Memory simplifies organizing your collection of vehicles.

Available on the App Store

ANDROID APP ON Google play





**E REVO**  
**BRUSHLESS EDITION**

OWNER'S MANUAL

MODEL 56086-4

**TRAXXAS**

6250 TRAXXAS WAY, MCKINNEY, TX 75070  
1-888-TRAXXAS